

KN SERIES



HeatNet[®] V3

Cast Iron Condensing Boilers Models KN-6, KN-10, KN-16, KN-20, KN-26 and KN-30

HeatNet[®] V3

Control adjustment and operation instructions for Advanced Thermal Hydronics firmware version 1.08

This instruction manual applies only to Advanced Thermal Hydronics firmware version 1.x on version 3.x control boards. Current firmware is backwards compatible with version 1.x & 2.x boards, but some current features may not be available. To replace firmware on an existing boiler, contact the factory to obtain the original firmware file or for assistance in applying current firmware to an older version control board.

Also read and follow:

KN-Series Gas Boiler Installation and Operating Instructions



ATH

ADVANCED THERMAL HYDRONICS

WARNING This manual is intended only for use by a qualified heating installer/technician. Read and follow this manual, all supplements and related instructional information provided with the boiler. Install, start and service the boiler only in the sequence and methods given in these instructions. Failure to do so can result in severe personal injury, death or substantial property damage.

WARNING **Do not use the boiler during construction.** Construction dust and particulate, particularly drywall dust, will cause contamination of the burner, resulting in possible severe personal injury, death or substantial property damage. The boiler can only be operated with a dust-free air supply. Follow the instruction manual procedures to duct air to the boiler air intake. If the boiler has been contaminated by operation with contaminated air, follow the instruction manual guidelines to clean, repair or replace the boiler if necessary.

CAUTION Affix these instructions near to the boiler/water heater. Instruct the building owner to retain the instructions for future use by a qualified service technician, and to follow all guidelines in the User's Information Manual.

TABLE OF CONTENTS

TABLE OF CONTENTS	2
Introduction	4
THE KN-SERIES V3 HEATNET CONTROL.....	4
Features & Specifications	6
STANDARD FEATURES OVERVIEW	6
Specifications	8
Components & Accessories	9
PART NUMBER COMPONENT	9
SETUP & OPERATION	10
BASIC MULTI BOILER SYSTEM OPERATION.....	10
MIXED BOILER TYPES USING PRIORITY SETS.....	11
MIXED BOILER SYSTEM OPERATION	11
START/STOP PRIORITY CONDITIONS	13
SELECTING MIXED BOILERS	14
MIXED SYSTEM TYPE 1: HIGH SYSTEM TURNDOWN	14
MIXED SYSTEM TYPE 2: CONDENSING / NON-CONDENSING	18
BASE LOADING, RELAY CONTROL	21
SETTING UP BASE LOADING.....	23
Heating Control Methods	24
HEATING METHOD 1	24
HEATING METHOD 2	24
HEATING METHOD 3	24
HEATING METHOD 4	24
HEATING METHOD 5	24
OPERATING LIMIT	24
INPUT PRIORITIES.....	24
HEATING METHOD 1 HEAT DEMAND.....	25
HEATING METHOD 2 STAGE CONTROL T1-T2	26
HEATING METHOD 3 4-20MA CONTROL	26
HEATING METHOD 4 AA INPUT	26
HEATING METHOD 5 MODBUS COMMUNICATIONS	27
Using the 4-20ma input (OPTIONAL)	28
SETPPOINT PRIORITIES.....	29
Circulator Pump Options	30
Auxiliary Function Options	32
Outdoor Reset	32
Sensors	33
Stack Temperature	33

Security 33

Saving Configuration Settings..... 33

USB Features 33

Diagnostics 34

Blower Protection 34

Communications..... 35

Failsafe Modes 35
 FAILSAFE REQUIREMENTS:..... 35

Flow Options 36

HeatNet Online 37

Domestic Hot Water Methods 39
 DHW METHOD 1: DHW HEATING ONLY USING A DHW MASTER AND MEMBER BOILER(S) EMPLOYING H-NET..... 39
 DHW METHOD 2: COMBINATION DHW AND SPACE HEATING USING A MASTER BOILER AND MEMBER BOILER(S) 41
 (MASTER TYPE: MIXED) 41
 DHW METHOD 3: DHW HEATING USING A HEADER SENSOR INPUT 43
 DHW METHOD 4: SPACE HEATING WITH DHW OVERRIDE OF SETPOINT ON MASTER..... 44
 DHW METHOD 5: DHW OF A LOCAL BOILER’S TANK..... 44
 DHW METHOD 6: DHW USING DIRECT CONTROL 47

Wiring Connections 48

Calibration..... 59

Log Entry..... 60

Default Settings & Menu Item Descriptions — SETUP 61

Default Settings & Menu Item Descriptions — ADVANCED SETUP..... 67

MODBUS Communications 74

Troubleshooting 85

KN HeatNet Control Run Screen..... 90

KN HeatNet Control Run Screen - Continued 91

KN HeatNet V3 Menu Tree — ADVANCED THERMAL HYDRONICS 92

KN HeatNet V3 Advanced Menu Tree – ATH 93

Worksheet 94

Information contained in this publication regarding device applications and the like is provided only for your convenience and may be superseded by updates. It is your responsibility to ensure that your application meets with your specifications.

Advanced Thermal Hydronics MAKES NO REPRESENTATIONS OR WARRANTIES OF ANY KIND WHETHER EXPRESS OR IMPLIED, WRITTEN OR ORAL, STATUTORY OR OTHERWISE, RELATED TO THE INFORMATION, INCLUDING BUT NOT LIMITED TO ITS CONDITION, QUALITY, PERFORMANCE, MERCHANTABILITY OR FITNESS FOR PURPOSE.

The Advanced Thermal Hydronics name and logo, Mestek name and logo, KN, HeatNet, and H-Net name and logo are registered trademarks of Mestek, Incorporated in the U.S.A. and other countries.

BACnet is a registered trademark of ASHRAE. LonWorks is a registered trademark of Echelon Corporation. All trademarks mentioned herein are property of their respective companies.
 © 2012, Mestek Technology Incorporated, Printed in the U.S.A., All Rights Reserved.

Introduction

The KN-Series V3 HeatNet Control

The KN-Series V3 boiler control is the third generation of the HeatNet control platform. Control hardware has been added to make use of many new heating applications. These new features are outlined in the Features & Specifications section.

The KN-Series boiler control is designed to provide the KN-Series of boilers with an integrated boiler management system on every boiler. Designed for the Air-Fuel coupled KN-Series boilers, the KN-Series HeatNet control provides for optimized heating efficiency without the need for a “wall mount control”. Since the KN-Series modular control method is based on digital communications, analog control signals are not required. Although the use of analog control signals is still supported (4-20mA control loops and 0-10vdc control voltages), a higher level of control precision, repeatability, and feedback is gained with digital communications control.

With the KN-Series, optimized heating efficiency is accomplished by setting the Modulation Maximum (Mod-Max) setting to exploit the inverse efficiency curve. This value can be adjusted so that as each boiler is added, it operates at its maximum turndown. This allows the maximum number of boilers to operate at their lowest inputs, until all boilers are firing. Once all boilers are firing, full range modulation control is allowed. An outdoor reset function is also provided to assist in the optimized heating efficiency of the KN-Series boilers.

The KN-Series boiler with the KN-Series H-Net control, can be operated in multiple ways:

1. As a stand-alone boiler.
2. A boiler in a Boiler Network using the HeatNet® (H-Net®) protocol.
3. A member boiler to a boiler management system with multiple input control methods.

The primary purpose of the control is to maintain the boiler water temperature at the supply or the header sensor using a target setpoint. While performing this task, the control also monitors dedicated external limits in a limit string and provides an orderly shutdown and fault indication in the event of a tripped limit. The monitored limits include a HIGH LIMIT AQUASTAT, LOW WATER CUTOFF, GAS PRESSURE, FLOW, IGNITION CONTROL fault, GAS VALVE alarm, VARIABLE FREQUENCY DRIVE alarm, and other optional or user selectable limits.

NOTICE

The HIGH LIMIT circuit is independent of the control and shuts down the ignition control and the boiler if the control board or other component of the boiler was to malfunction. The control will continue to function and report the fault, but its ability to control the boiler will end.

Each KN-Series boiler employing this control can function as either a master or a member. This allows one boiler (Master) to be in control of target temperature. The other boilers (Members) only respond to the commands issued by the Master. If using an external control, all boilers can be setup as members. The following will define the roles of master and member.

Master

A boiler becomes a master when a temperature sensor is connected to the J10 “SYSTEM HEADER” terminals. The sensor is auto-detected.

The master senses and controls the common system header/loop water temperature using a system setpoint. It uses any boilers it finds (over the H-Net communications cable) to accomplish this. It can also monitor the Outside Air (OA) temperature to provide outdoor reset functionality. **Only one master is allowed in a system.**

When operating as a master, the boiler provides a control method using a PID algorithm to regulate water temperature. This algorithm allows a single boiler (Master), or multiple (Master + Member) boilers.

Figure 1 Heat band

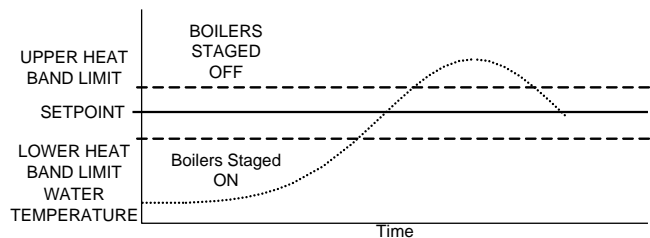

The control algorithm is based upon a Heat Band, at the center of which is the setpoint. While below the Heat Band, boilers are staged on and modulated up until the Heat Band is entered. Once in the Heat Band, modulation is used to maintain setpoint. Boilers are shut down only when the top of the Heat Band is breached. Timers are also used to prevent short cycling.

While staging the boilers on, a modulation clamp **ADVANCED SETUP: MODULAR BOILER SET: MOD MAX-LAST FIRE** is used to hold the boilers at a lower fire rate until the last boiler is fired. Once the last boiler fires, the modulation clamp is removed and all boilers are allowed to fire above this clamped percentage up to

100%. This “boiler efficiency” clamp is defaulted to 70% and thus limits all of the boilers individual outputs to 70% until the last boiler fires. All running boilers modulate up and down together, always at the same modulation rate. As a general rule, this percentage should be no lower than twice the minimum turndown to minimize short cycling.

When additional boilers are needed to achieve setpoint in the system, the Master boiler employs an ADAPTIVE MODULATION algorithm to prevent over firing of the system. The Master communicates over the H-Net to view the exact status of each Member boiler. When a new boiler is added, the Master boiler adjusts the system modulation rate lower to compensate for the BTUs that will be introduced by the newly added boiler. This adjustment occurs when the newly added Member boiler enters its ON CALL state (default setting). This can be changed to PILOT when the new boiler is called using the menu:

ADVANCED SETUP:ADAPTIVE MOD:DROP DOWN. Once the Main Valve (on the newly added boiler) is opened, and the **DELAY RELEASE** timer equals zero, the PID algorithm is allowed to control the system modulation. **Setting** the DELAY RELEASE timer will allow some “soak” time of the newly added boiler before releasing modulation control to the PID.

NOTICE

The ADAPTIVE MOD menus are disabled on a Member boiler, but are still visible.

Member

If a “SYS/DHW HEADER” sensor is **not** connected to J10, a boiler always defaults to the role of Member.

The Member boiler can operate as part of a multi-boiler system or as a stand-alone unit.

In a multi-boiler system the Member typically receives its command signals from a designated Master-boiler. It is also capable of receiving inputs from an external control system. The boiler responds to these signals, to start/stop the burner, and/or to modulate the firing rate. The outlet water temperature is also monitored. If the outlet temperature approaches the operating limit temperature setpoint (adjustable), the boilers firing rate is limited and its modulation value is reduced to minimize short-cycling. If the operating limit is exceeded, or if an interlock trips, the boiler is shut down. When connected with a network cable, in a Master/Member role, the Members' status is interrogated by the Master boiler.

In a stand-alone installation the Member typically receives its command signals internally and operates based upon the outlet water temperature input and the established settings in the menu (Local Set-point) to start/stop the burner, and/or to modulate the firing rate. If the operating limit is exceeded, or if an interlock trips, the boiler is shut down. As in a multi-boiler system, a stand-alone Member boiler is also capable of receiving inputs from an external control system.

When using the H-Net network cable in a Master/Member system, the system setpoint is sent from the Master as a digital signal, along with the modulation value to control firing rate. It also receives its command to start or stop over the H-Net cable. Also, the SYSTEM CLOCK only needs to be set on the MASTER. The Master will then set the time on all member boilers.

If not using the H-Net protocol (cable), an external control can send a 4-20ma signal along with a 4-20ma enable signal to control the firing rate or setpoint. The boiler may also be treated as a 2-stage boiler or an ON-OFF boiler using the dedicated T-inputs.

Features & Specifications

HeatNet Version 3.x Discontinued Features from Version 2.x Control

1. With this hardware release the service power, switched power, and the power switch connector have been removed. These were available on prior versions of the HeatNet control. Upgrading to this control from prior versions will require some wiring changes using an upgrade kit.
2. The J10B input is no longer supported for proving the damper. Damper proving switches will need to be wired to J12B. J10B wires from the prove switch should now be connected to J12B.
3. If a stack sensor is used with this version, the alarm silence switch can not be connected and the disconnected wires should be terminated appropriately.

Silencing the alarm can be done by holding the BACK and SELECT keys down at the same time.

Hardware Version 3.x Control

Additional Features (Identified by circuit board color: BLACK)

1. Support for (2) Circulator pumps. Two rotation modes are provided: Based on system runtime or system pump runtime hours. Pump failure switchover/retry mode.
2. Warm weather shutdown, (2) pump jog and local pump jog to keep pumps from seizing.
3. The Modbus, BACnet or LonWorks communications port can be accessed concurrently with the USB port (HeatNet Control Pro). The BACnet, LonWorks, or Modbus connections do not need to be disabled to use the USB ports.
4. The DHW pump and the Local Pump relay connections now provide a normally closed contact. This allows for the use of a power open/power close valve.
5. Support for 5ma 0-10v control signals using third party controls.
6. Support for (2) display types: Vacuum Florescent and Color LCD using the same 20 pin ribbon cable.
7. System Return sensor input.
8. Enhanced bootloader and firmware storage. One firmware storage location for user updates. One

firmware program that always remains resident so that a factory program can be restored. Primary loading is with a flashdrive.

9. Support for High Efficiency Ametek blowers.
10. 32 bit Microcontroller operating @64Mhz with 5-stage pipeline, and prefetch cache.
11. (3) stage control relay outputs for TBD applications.
12. Backwards compatible with existing HeatNet versions 1.x and 2.x controls and applications.
13. Support for 135 Ohm control actuators.
14. 1k Platinum Stack sensor
15. Flow meter input or BMS GPM input/control
16. On-board HeatNet Online network module.
17. Dual PID controls. One for space heating and one for DHW heating. Allows for simultaneous DHW/Space heating.

Standard Features Overview

1. Five levels of external control inputs, including modulation and staging that provide application flexibility.
2. Digital Communications Control (analog 4-20ma and 0-10vdc control supported, but not required).
 - a. Boiler to Boiler : HeatNet (H-Net)
 - b. **Building Management System (MODBUS, Optional BACnet or LonWorks) to Boiler**
3. Distributed control using the HeatNet (H-Net) protocol for up to 16 boilers. Eliminates the need for “wall mounted” controls.
4. Analog Control 4-20ma and 0-10vdc (5mA minimum current) signals supported.
5. System/Boiler operating status text display
6. Interlock, Event, and System logging with a time stamp.
7. Advanced PID algorithm optimized for the KN-Series boilers.
8. (4) Dedicated temperature sensor inputs for: Outside Air Temperature, Supply (Boiler Outlet) Temperature, Return (Boiler Inlet) Temperature, and Header (Common System Supply) Temperature.
9. Automatically detects the optional temperature sensors on power up.

10. Menu driven calibration and setup menus with a bright (Adj.) 4 line Vacuum Fluorescent Display.
11. (8) Dedicated 24vac interlock monitors, and 8 dedicated 120vac system monitors used for diagnostics and providing feedback of faults and system status.
12. Multiple circulator pump control modes.
13. Combustion Air Damper control with proof time, support for a common combustion air damper.
14. USB/RS485 network plug-in to allow firmware updates or custom configurations.
15. Optional BACnet or LonWorks interface.
16. Alarm Relay dry contacts, and Audible Alarm.
17. Runtime hours, and Cycles (based on Main Valve Open).
18. Outdoor Air Reset with programmable setpoint and ratio.
19. Time of Day clock to provide up to (4) night setback temperatures.
20. Failsafe mode when a Building Management System is controlling setpoint. If communications is lost, the boiler/system automatically transfers to local boiler setpoint control.
21. Rotation Methods(Lead-Lag): True Rotation (based on boiler runtime)is default. First On First Off (FOFO), Last On First Off (LOFO) and MIXED are optional.
22. Programmable password protection to secure the programmable settings.
23. Remote 4-20mA setpoint control using a mapped setpoint range to the 4-20mA control signal.
24. Freeze Protection allowing automatic starting of boiler(s) using (2) Failsafe modes.
25. Adaptive Modulation. When additional boilers are called, the Master adjusts all boilers fire rates to compensate.
26. Mixed boiler types in a system.
27. Support for Domestic Hot Water (DHW) using a 10k Sensor or a dry contact input from a tank thermostat.
28. Domestic Hot Water relay for use with a pump or valve.
29. On-board power and socket for Protoessor BACnet/LonWorks module.
30. HI/LO relay control option from connector J4
31. Resettable Fused interlock power circuit.
32. Additional terminal connector for H-Net shielded cable.
33. Backwards compatible to Version 1.x hardware.
34. Communications board integrated with the main board from version 1.x control.
35. Base Loading of (1) boiler.
36. Delayed Blower Power staging. Used to minimize inrush currents by powering the blower 7 seconds after main power.

Specifications

Control	Microprocessor based PID modulating control (NOT a safety limit)
Environment	-40 °F to 140 °F, <90% RH non-condensing
Input Power	24 VAC, 500 ma
Relays	System Pump, Damper, Circulator, Alarm, DHW Pump (v2.x), 8A 250 VAC resistive K8 on J4.2 & .6 for Base Loading version 2.x Control
AC Interlocks	24 VAC – 120 VAC input
Control Inputs	AA, Heat Demand, 4-20ma Enable, OA override, T1-T2 (dry contact inputs) 4-20mA, 0-10 VDC
Dimensions	9” wide: 6” high : 2” deep
Temperature Sensors	NTC thermistor, 10K @ 77 °F, 335.67K @ -40 °F, 185 @ 150 °F ,+/- 1 °F
USB	1.0
RS485 MODBUS	Modbus RTU
Boiler-to-Boiler	HeatNet (H-Net)
Network	Optional LonWorks, BACnet available bridge to MODBUS port

Components & Accessories

Part Number	Component
02-4297	KN-Series Control Board Version 3.x
02-4278	Graphics Display Board Color Touch Panel Display
02-3926	ACI/10K-CP-BP Temperature probe (bullet type, 1x.250 inch)
02-4283	ACI 10k-CP-I-NW Supply, Header, Return Sensors
02-4285	ACI CP-I-2.5" Sensor with well
02-4286	ACI CP-I-4" Sensor with well
02-4281	ACI 10k-CP-S Strap-on sensor ACI X/(2) CP-PO -4 4" probe with dual sensor ACI X/(2) CP-PO -6 6" probe with dual sensor
02-4280	ACI 10k-CP-O Outside Air Sensor with Housing
0040-1300	1k Platinum Stack sensor Installation & Operation Manual
40-5409	RJ45 Communications Cable Assembly, 25 feet
40-5411	Ribbon Cable Assembly (Display Control)
58-1833	10k ohm Calibration Resistor
40-5408	USB Cable Assembly, 6ft
60-5631	Terminal Block Screwdriver
Contact Factory	MODBUS to BACnet bridge
Contact Factory	MODBUS to LonWorks bridge
Contact Factory	MODBUS to HeatNet Online bridge

SETUP & OPERATION

Basic Multi Boiler System Operation

NOTICE For boiler system setup/installations please refer to Refer to the *2008 ASHRAE Handbook, CH12* or later revision.

A basic multi boiler system typically uses boilers of the same size and type. With HeatNet, this includes (1) Master and (1-15) Member boilers. The boilers are connected together using an H-Net communications cable effectively creating (1) boiler. This allows the system heating BTUs to be evenly distributed amongst all of the boilers. (See: Figure 35, Typical Single Boiler System, page 55).

Figure 2 Basic multiple boiler system

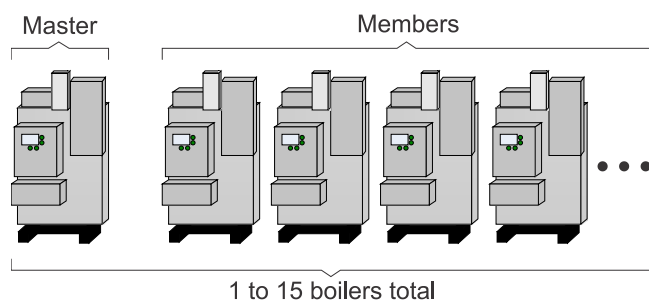

A basic multi boiler system can be configured using the boiler menus to create custom systems/features. These features are best described in the section: **Default Settings & Menu Item Description**, page 61. **Along with these menu items are hardware support for many auxiliary functions.**

Once the system has been properly setup (all default menu values used and H-Net addresses assigned), the system is enabled by placing the REMOTE/LOCAL switch to the LOCAL position on the Master boiler. All Member boilers must have their respective switches in the REMOTE position. When the Master boiler's Heat Demand input (LOCAL switch) closes, the system becomes operational and will fire as many boilers as it needs to maintain the header water temperature's setpoint. See the DHW section to fire to two setpoints.

When a boiler is to be fired in a multi boiler system (header water temperature is below the heating band), the Master checks the HeatNet boilers it has available. Then the Master checks if a Lead Boiler is to be used (LEAD BOILER > 0). The Master boiler then looks at which type of firing rotation it has selected: LOFO, FOFO, TRUE (runtime), or MIXED. In our example we will use the TRUE (runtime) rotation since it is the default.

The Master now checks all of the runtimes to determine which boiler has the least runtime based on the MIN RUNTIME setting in ADVANCED SETUP:FIRING MODE:. The MIN RUNTIME setting is the minimum runtime interval in hours that is used to compare boiler to boiler runtimes.

Once the boiler to fire has been determined, the Master sends the command over the H-Net cable to fire that boiler and resets the ADD BOILER delay timer to prepare for the next boiler to fire. If the header water temperature is still below the heating band and the ADD BOILER delay timer has expired to zero, the process is repeated until the header water temperature enters the heating band.

When a boiler receives a command to fire:

1. The system pump relay is enabled and the H-Net control displays 'Flow Wait' until the flow-switch closes between J11A, 1 & 2 within the programmed time (10seconds).
2. All elements in the interlock string, terminated between J11A and J11B, must be closed before the sequence is allowed to continue.
3. If all interlocks are closed relay K5 is enabled to command the combustion-air damper open (If used). The H-Net control displays 'Damp: Wait' until the damper end switch closes.
4. Relay K6 is enabled energizing the local pump (if used). The H-Net control commences its 'Flow-Wait' timer (adjustable 10–240 sec.). The flow switch contact is checked on terminals J11B, 5 &6.
5. With all the interlocks closed, the boiler start relay K1 is enabled and energizes terminal 6 on the ignition control. This signal is present on **J5 Boiler Start Operator**.
6. The ignition control begins its cycle and provides an output signal from terminal 4 to the H-Net control **J5 Blower**. The H-Net control responds and provides an output signal to the VFD which sets the blower to the programmed pre-purge speed. If an Ametek blower is used, a soft start speed is applied before the pre-purge speed.
7. After air-flow is established the ignition control waits for the air switch to close. When the air switch closes it provides an input to terminal 7 and pre-purge timing commences. The H-Net display indicates 'Pre Purge'.
8. When purge is complete the ignition control energizes the pilot gas valve from terminal 8, and the spark generator from terminal 10, beginning a 10-second Pilot Flame Establishing Period (PFEP). The H-Net control responds to **J5 Pilot Valve** and provides an output signal to the VFD which sets the blower to the programmed ignition speed. The H-Net display indicates 'Pilot'.
9. At the end of the PFEP the spark generator is de-energized. If the pilot flame is detected, by the UV scanner, the ignition control energizes the main gas

valve from terminal 9 to **J5 Main Valve**. The H-Net display indicates 'Run'.

10. If main-flame is detected the H-Net control holds the burner at the low-fire rate for the MODULATION DELAY time period. After this timer expires, the PID allows the boiler to modulate and places the boiler into the running state.

As boilers are added to the system settings in the **ADVANCED SETUP: ADAPTIVE MOD: DROP DOWN** menu determines when the modulation rate drops down to compensate for the newly added BTUs. For the drop down to be active, one boiler needs to be running when a new boiler is added (see: *Introduction: The KN-SERIES H-Net Control: Master*).

If all boilers are firing, the modulation rate is released to go to 100%. If all boilers are not firing, the modulation is limited to the MOD-MAX clamp value. The MOD-MAX clamp is used to keep the boilers running as efficiently as possible. The following *Mixed Boiler System Operation: Selecting Mixed Boilers* section outlines this with examples.

NOTE: If the boiler is running as a stand-alone boiler or is direct modulated (including the AA input), the MOD-MAX clamp will also be in effect for the ADD BOILER DELAY time. This is to minimize thermal shock to the boiler.

Once the header water temperature is in the heating band, only the modulation rate is used to achieve the target setpoint. The system will maintain the setpoint until the load demand increases or decreases.

As the load decreases, the header water temperature will start approaching the top of the band. The PID now lowers the modulation rate to the boilers, attempting to keep the temperature within the heating band. If the system is delivering too many BTUs, the water temperature will cross the top of the heating band.

When the header water temperature first exceeds the top of the heating band, the boilers are again checked for the one with the most runtime. The selected boiler will turn off immediately and a shed boiler delay timer will be loaded with the delay time. This time will need to expire before the next boiler will be stopped, but only if the header water temperature remains above the heating band. This timer is used to allow the header water temperature to return back into the band when a boiler is stopped. When a boiler is stopped there is a fixed rate of BTUs (Min Fire) that will be removed (PID discontinuity to modulate from Min Fire to 0 BTUs on a boiler). The timer allows for this loss of BTUs.

This cycle will continue until the call for heat is satisfied or the Warm Weather Shutdown feature is enabled.

Mixed Boiler Types Using Priority Sets

Using the *Basic Multi Boiler System Operation*, a MIXED boiler Priority method may be added to control condensing, non-condensing, base load, or other boiler **SETs** in a system together. These sets compose a system which provides for optimal performance and economy. Having dedicated sets of boilers gives the system engineer a tool to create many different boiler systems.

A boiler set can be constructed by simply setting the firing Priority on each boiler (to be in a set) at the same priority. Setting all (example) condensing boilers to the highest Priority of 1, and then setting all (example) non-condensing boilers to a Priority of 2, will create (2) sets of boilers, one condensing and the other non-condensing. Once this is done, the Priority 1 set of condensing boilers will have a firing order that has a higher Priority and is independent of the other non-condensing set with the lower priority. The boiler set with the highest Priority can then be fired based on a conditional settings menu. The lower Priority set will follow.

Mixed Boiler System Operation

Starting Boilers:

When a boiler is to be fired (water temp is below the heating band), the Master checks the HeatNet boilers it has available. The Master boiler then looks at which boilers are returning Priority firing status (set on a boiler in: (ADVANCED SETUP:SYSTEM:BOILER TYPE:PRIORITY : 1). If the Start condition for the Priority 1 set is met (ADVANCED SETUP:FIRING MODE: MODE: MIXED:SET *FIRST* (example), the Master or Member boiler that is configured as PRIORITY 1, with the lowest runtime, will be fired *FIRST* (example).

As long as the start condition for Priority 1 is met, all boilers in the PRIORITY 1 set will fire based on runtime. Once all boilers in the PRIORITY 1 set have fired, the PRIORITY 2 set of boilers will fire based on runtime.

If the Start condition changes and/or is not met (such as with: OA T or RET temp), the PRIORITY 2 set of boilers will fire first/next based on runtime. This has the effect of flipping the Priority of the sets.

Stopping Boilers:

When a boiler is to be stopped (water temp is above the heating band), the Master checks the HeatNet boilers it has available. The Master boiler then looks at which boilers are returning Priority firing status (set on a boiler in: (ADVANCED SETUP:FIRING MODE: MODE: MIXED:SET *LAST* (example) If the Stop condition for Priority 1 is met, the Master or Member boiler that is

configured as PRIORITY 1 with the highest runtime will be stopped *LAST* (example). As long as the stop condition and SHED DELAY time are met, all remaining PRIORITY 1 set of boilers will stop based on runtime. If the Stop condition changes and/or is not met (such as with: OAT or RET temp), the PRIORITY 2 set of boilers will stop first/next based on their highest runtime.

A boiler's firing Priority can be designated as such in: **ADVANCED SETUP:SYSTEM:BOILER TYPE:FIRING PRIORITY : 1** menu on each boiler. A Priority of '1' is the highest priority, a '2' the lowest (default is always 2).

Figure 3 Mixed Boilers: Example: Condensing/Non-Condensing

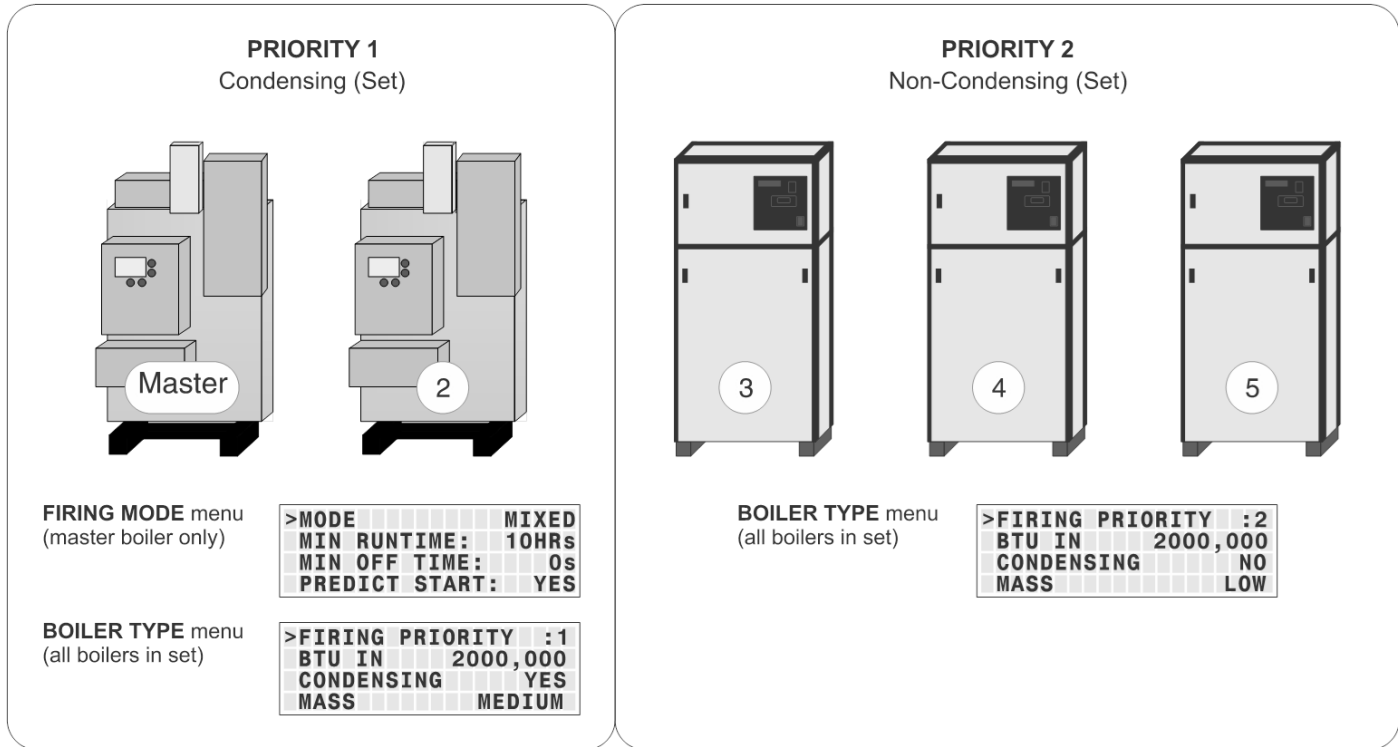

In the example *Mixed Boilers: Condensing/Non-Condensing*, condensing boilers and non-condensing boilers are used, but other combinations may also be used. Another example could use (2) small boilers and set them to Priority 1 and then use (3) larger boilers and set them to Priority 2. Using these Priority settings (with the conditions menu), the small boilers can run first during the shoulder months (Spring and Fall) and the larger boilers can fire last during the colder Winter season (base loading set).

Before the MIXED method can be used, the firing mode on the Master boiler must be set to **MIXED**. **ADVANCED SETUP:FIRING MODE: MODE: MIXED**. Pressing the SELECT key when the cursor is pointing to **MIXED** will enter the conditions menu. The **START** and **STOP** conditions for starting and stopping the Priority boiler set may be configured here. Temperatures are adjustable.

START	PRIORITY	1			
>SET :	FIRST				
STOP	PRIORITY	1			
SET :	OAT <		15 ° F		

Once the conditions menu has been entered, the firing order and stop order of the Priority 1 boiler set can be selected based on up to (3) conditions in the conditional settings menu. All conditional settings apply to the Priority 1 boiler set. When the conditional settings do not apply to the Priority 1 set, the conditional settings will apply to the Priority 2 boiler set.

Note: If the firmware version for a HeatNet V2 board is at least 3.47 (or a version 3 board), the non-condensing boiler may hold itself off from being added to the HeatNet Master's available to fire list. This would effectively keep the non-condensing boiler from firing in a condensing mode, but as a result, may not satisfy the system setpoint. See: **SETUP:AUX FUCTIONS:HEAT EXCHANGER TEMP DISAB:**

Start/Stop Priority Conditions

The following is an example using mixed condensing and non-condensing boilers:

FIRE FIRST

Condensing boilers may be configured to **fire first** (set to PRIORITY 1) when:

- The Return water temperature is below 140F and condensing occurs. (The Master’s return water sensor would need to be moved to the header return.)
- The Outside Air Temperature is above a setpoint determined by the system configuration. This setpoint ensures that the more efficient condensing boilers run first during shoulder months (Spring and Fall) when minimal heating is required. Below this setpoint, larger boilers should be brought on first to “base load” the system.
- Greater efficiency is required.

STOP FIRST

Condensing boilers may be configured to **stop first** (set to PRIORITY 1) when:

The Return water temperature is above 140F and condensing is minimized, thus leaving the larger lower cost boilers running to carry the load.

- The Outside Air Temperature is below an adjustable setpoint determined by the system configuration. This setpoint ensures that the larger non-condensing boilers run during the coldest months when maximum heating is required. Above this setpoint smaller condensing boilers should be brought on first to run the system as efficiently as possible.
- Maximum heating is required

START PRIORITY 1 SET

Selections (always the lowest runtime first):

NOTICE The *condensing boiler set* (Priority 1) has a higher Priority to *fire* when one of these conditions is met. Values are adjustable.

FIRST: The condensing boilers (Priority 1) are always started FIRST

OA T > 15F: The condensing boilers (Priority 1) are started when the OA temperature is greater than the Mixed Boiler Outdoor Air Temperature setting.

RET < 140F: The condensing boilers (Priority 1) are started when the Return water temperature is less than the Mixed Boiler Return temperature setting (This may not be applicable in most configurations since the local return

temperature on the Master is used to provide a difference temperature across the heat exchanger. A System Return sensor will be required. However, the return temperature sensor may have been moved on the Master to provide system return temperature on existing installations and is still supported).

STOP PRIORITY 1 SET

Selections (always the highest runtime first):

NOTICE The *condensing boiler set* (Priority 1) has a higher Priority to *stop* when one of these conditions are met. Values are adjustable.

LAST: The condensing boilers (Priority 1) are always stopped LAST.

OA T < 15F: The condensing boilers (Priority 1) are stopped first when the OA temperature is less than Mixed Boiler Outdoor Air Temperature.

RET > 140F: The condensing boilers (Priority 1) are stopped first when the Return water temperature is greater than the Mixed Boiler Return temperature. (This may not be applicable in most configurations since the local return temperature on the Master is used to provide a difference temperature across the heat exchanger. However, the return temperature sensor may be moved on the Master to provide system return temp if the difference temp is not required)

Start/stop settings

Any combination of Start Conditions and Stop Conditions can be used to optimize the mixing of condensing (Priority 1) and non-condensing boilers (Priority 2) for best performance/economy.

The default settings for the start and stop conditions of the condensing set are:

START PRIORITY 1									
>	SET	:	FIRST						
STOP PRIORITY 1									
	SET	:	LAST						

The default start setting always starts the condensing boilers (Priority 1 example) first, except for the lead boiler setting. The **lead boiler** will always start first if enabled, unless there is a boiler already running (this includes a Member boiler in LOCAL). The default stop condition setting always stops the condensing boilers (Priority 1) last.

If prolonging the life of the heat exchanger(s) on non-condensing boilers is very important, consider starting the condensing boilers (KN series) when the return water temperature is below 140F.

NOTICE The return water temperature sensor would need to be moved from the Master’s return inlet to the system return. The **EXCHGR DELTA** may need to be adjusted in **SETUP:AUX FUNCTIONS:HEAT EXCHANGER** to prevent the Master from going to ½ input when a high **DELTA T** is reached.

This method would lead to the non-condensing boilers carrying the load when the system temperature stabilizes above 140F, since non-condensing boilers will start first with the Return water temperature is > 140F. The condensing boilers can then be stopped first when the RET water temperature is above the 140F. Remember, any combination of the Start and Stop conditions may be applied for best performance and economy in the system. Also, non-condensing boilers may be set to go offline when a return temperature is too low using the **SETUP:AUX FUNCTIONS: HET EXCHANGER: TEMP DISAB** menu..

Base load boilers can also be mixed in the same way as condensing and non-condensing boilers. The base load boiler(s) can be prioritized in one set (example, Priority 2) and non-base load boilers (Priority 1). The non-base load boilers can then be set to fire first and once they are all firing, the base load boiler would fire.

To minimize the cycling of a large base load boiler, consider using the stop condition. Change it to the OA T < 15F (Outside Air Temperature) condition. This setting may be used to stop the Priority 1 boiler set when the OA T drops below the OA T setpoint, thus leaving the large base loaded boiler on and shutting off the condensing boilers first. This is also true when using the OA T setting to start the Priority 1 boiler set when the OA T is above the start setpoint. To use temperatures as start and stop conditions, the system design temperatures must be known.

Selecting Mixed Boilers

There are a few factors to consider when choosing which type of boilers to use in a mixed system. These factors need to be considered when boilers are added or shed. When BTUs are introduced into the system by adding boilers, the amount of introduced BTUs should be smooth (linear). If these factors are not considered, discontinuity in BTUs may occur when boilers are added and as a result, short cycling will occur.

- 1. Turndown:** This is the ratio of minimum fire rate to maximum fire rate: Example: a 20% minimum modulation = 5:1 turndown (100% mod / 20% mod). A (1) million BTU boiler = 200,000 BTUs minimum input.
- 2. MOD MAX CLAMP:** This value determines the maximum modulation % at which the boilers will fire to until all available boilers are firing.

- 3. Total System BTUs.**
- 4. Desired Effective Turndown.** This is the lowest firing rate of the system relative to the maximum firing rate of the system. The larger the value, the lower the BTUs that can be delivered to a light load.
- 5. Piping.**

Mixed System Type 1: High System Turndown

The following examples are of mixed boiler systems with high effective system turndown and fault tolerance built in. When boiler types are the same, the system turndown is limited to the boiler’s min input and fault tolerance is always present. When the system has mixed boiler types, consideration needs to be taken on what types can be mixed properly to achieve a high system turndown and provide some fault tolerance.

Fault tolerance allows for one boiler in the Priority 1 system to fail and any boiler(s) in the Priority 2 system to fail and still provide near linear (continuity) BTU response when adding boilers. This is illustrated in the following examples using the Boiler System Response graphs.

The KN Mixed Boiler System (examples) is advantageous in providing low BTU input for light loads and high BTUs for heavy loads. The effective system turndown minimizes short cycling when light loads are present by assigning smaller boilers to Priority 1, running them first, and then stopping them last.

NOTICE In order to achieve the high effective turndown, smaller boilers are required (plumbing considerations need to be considered here due to differing flow/volume characteristics through the large and small boilers).

Example Systems:

Figure 4 Non-Mixed Boiler System

System MMBTU	Effective Turndown	MOD MAX	MB/MW 4:1
10.0	25:1	70%	KN20, KN20, KN20, KN20, KN20
5.0	25:1	70%	KN10, KN10, KN10, KN10, KN10
3.0	25:1	70%	500, 500, 500, 500, 500

With the traditional Non-Mixed boiler system, the effective turndown increases by the turndown ratio for every boiler

added. The min fire rate is equal to the minimum BTUs that can be delivered to the system.

Number of boilers * Turndown Ratio = Effective System Turndown: 5 * 5:1 = 25:1.

Figure 5 Mixed Boiler System

System MMBTU	Effective Turndown	MOD MAX	Priority 1 5:1	Priority 2 4:1
4.2	35:1	60%	KN6, KN6	KN10, KN10, KN10
3.8	42:1	70%	KN4, KN4	KN10, KN10, KN10
2.2	55:1	81%	KN2, KN2	KN6, KN6, KN6
3.6	90:1	72%	KN2, KN2, KN2	KN10, KN10, KN10

With the mixed boiler system, a lower minimum fire rate/BTU can be delivered to the system by using small boilers with larger boilers. This works in much the same way as base loading.

Figure 6 KN Boiler Btu Chart (MBH)

	KN2	KN4	KN6	KN10	KN20	KN30
Max Input	200M	400M	600M	1MM	2MM	3MM
Min Input 5:1	40M	80M	120M	200M	400M	600M
Mod Max 80%	160M	320M	480M	800M	1.6MM	2.4MM
Mod Max 70%	140M	280M	420M	700M	1.4MM	2.1MM
Mod Max 60%	120M	240M	360M	600M	1.2MM	1.8MM
Mod Max 50%	100M	200M	300M	500M	1MM	1.5MM

When selecting the **Priority 1** boiler(s) for a high effective system turndown, the BTU Min Input is selected first. (See: *KN Fusion & Boiler Btu Chart*). Next, the MOD-MAX value of this Priority 1 boiler needs to be greater than: **Mod MAX % =**

$$\frac{((\text{Priority 1 's Min Input} + \text{Priority 2 's Min Input})}{\text{Max Input of the Priority 1 boiler}}$$

The reason for this is keep the continuity of BTUs linear without a BTU bump (discontinuity) when boilers are added or shed. This is illustrated in the *Boiler System Response 2* graph.

If redundancy is not required, the min inputs of the Priority 1 boilers may be summed to lower the Mod Max % value so smaller Priority 1 boilers can be used. The sum of the min inputs would then need to be divided by the sum of the Max Input of the Priority 1 boilers. The effect of this would create a higher turndown. See: *EXCEPTION NOTES:*

Mod MAX % =

$$\frac{((\text{Priority 1 Min}) * (\#\text{Priority 1's})) + \text{Priority 2 Min}}{\text{Max Input of Priority 1 boiler} * (\#\text{Priority 1's})}$$

Example: (2) KN6s, (2) KN20s
 Redundancy: (120 + 400)/600 = 87%
 No Redundancy: (120 * 2) + 400)/(600*2) =54%

EXCEPTION NOTES:

1. Mixing more than two different size/type boilers becomes more complex than the scope of this manual.
2. If using more than one Priority 1 boiler and the calculated value is <

$$\frac{\text{Priority 1Min} * 2}{\text{Priority 1 Max Input}}$$

Use this result PLUS note 3 value as the ModMax%.

3. Always add a few % (3-5%) to the calculated MOD MAX % value to allow a guard band (tolerance).
4. If boilers are of different sizes, try to use larger Priority 2 boilers.

If the calculated Mod MAX % value is greater than 99%, the combination cannot be used since short cycling will occur.

Once the Priority 1 and Priority 2 boilers are selected, they can be multiplied in each Priority set to achieve the desired system design BTUs. If the # of boilers becomes a large number, a Priority 1 boiler with a higher Min Input may need to be selected.

While considering the MOD-MAX value, the lower the MOD-MAX the greater the combustion efficiency since it effectively limits the input rate. The Typical Efficiency of Non-Condensing Boilers chart can help illustrate how the MOD-MAX value can affect the efficiency by limiting the input until all boilers have fired. Non-condensing boiler efficiency is relatively flat compared with condensing as illustrated in the Typical Efficiency of Condensing Boiler graph.

Figure 7 Typical efficiency of condensing boilers (GAMA BTS2000 method)

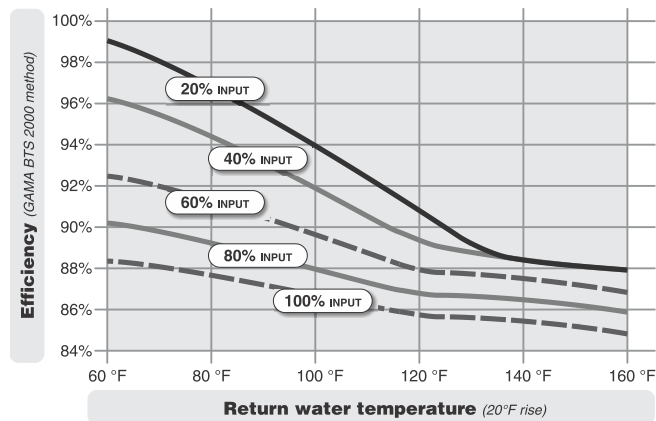

In the Mixed Boiler System table (line 1), KN6s are set as Priority 1 and KN10's set as Priority 2. With a MOD MAX

of 60%, each KN6 can run to 360M (720M total) before a KN10 is called ON (Add Delay timer set long enough). Once both KN6s are running and the KN10 is then called on and running, all (3) boilers will drop to a total of the 720M BTUs: The sum of the KN6, KN6, and KN10. About 33% modulation: (.33* 600M) + (.33* 600M) + (.33* 1MM) or: 198M +198M + 330M = 726M and operate at higher combustion efficiencies. 33% is roughly between the top two lines on the Typical Efficiency of Condensing Boilers chart.

Figure 8 Boiler System Response 1 (2) KN2s, (3) KN6s

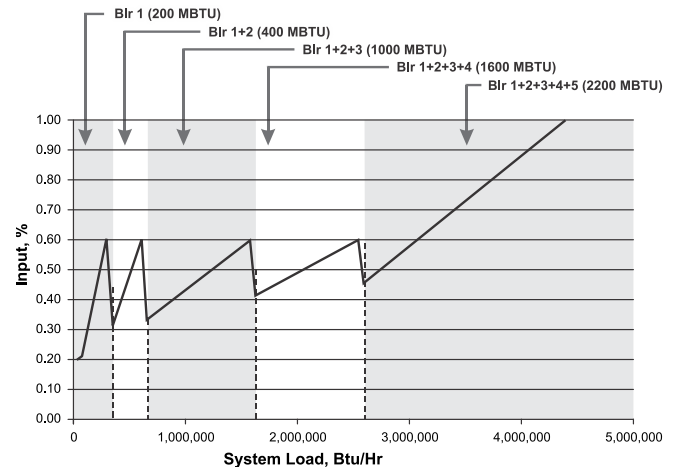

NOTICE When running non condensing boilers at low input rates, the risk of condensing should be considered.

The *Boiler System Response 1* chart illustrates how each boiler (in the example) is brought on and fires to 60%, drops to a lower fire rate and then adds the next boiler (vertical dashed lines). Once all boilers are firing, the modulation is released allowing all boilers to fire to 100%. So, for the first 2500 MBTH of load, the combustion efficiency is maximized by running the boilers from low to middle input rates.

Now if a (2) boiler system (one of the KN6s & two KN20s brought offline) using (1) KN6 with (1) KN20 and MOD-MAX set to 60%, the KN6 would fire to 360 MBTUs and wait for the KN20 (*Boiler System Response 2* graph). Once the KN20 fired, the input rate would jump to 520 MBTUs, 400M (KN20 @ 20%) + the 120M (KN6 @ 20%). There would be 160 MBTUS more than needed.

The PID algorithm would then compensate for the large discontinuity (over fire bump) in BTUs and the KN20 would shut off (short cycle). This discontinuity is observed in the graph below, (*Boiler System Response 2*) where the jump from the KN6 @60% to the firing of the KN20 is apparent.

Figure 9 Boiler System Response 2
(1) KN6, (1) KN20, 60% Mod-Max

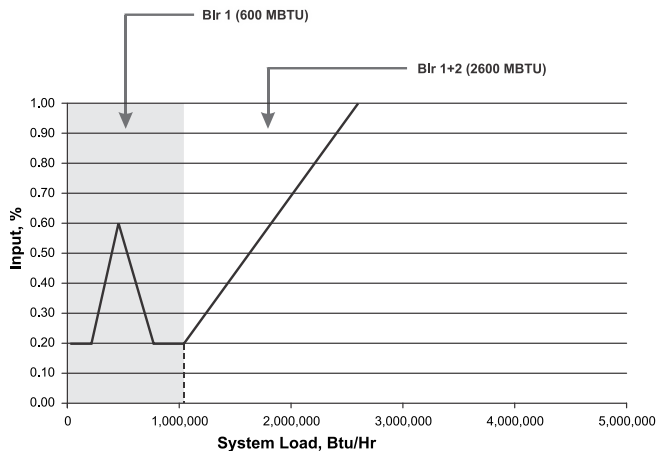

To correct this would require the KN6 to set the MOD-MAX to roughly 90% (Boiler System Response 3: not as efficient as it could be) in order to have a linear BTU transfer when the KN20 is added (fired).

Figure 10 Boiler System Response 3
(1) KN6, (1) KN20, 90% Mod-Max

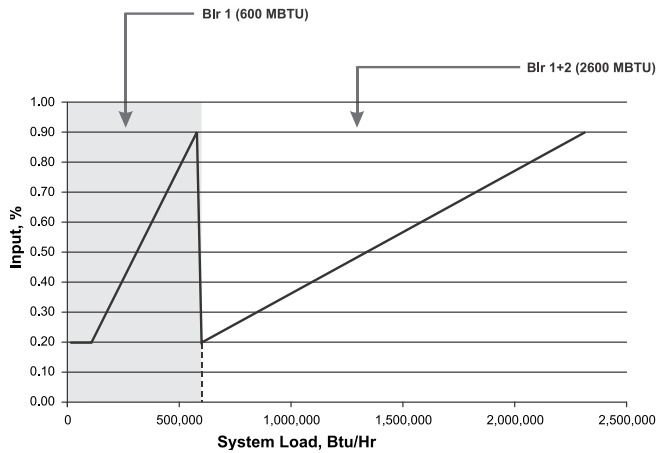

A KN6 running with a KN20 may not be an optimal choice unless (2) KN6's are always functional and used in the Priority 1 set or (3) KN6s and one is allowed to be taken offline.

A system employing this redundancy where (1) is allowed to be taken offline is listed in the MIXED BOILER SYSTEM chart. The example system uses (3) KN2s and (3) KN10s. Two of the KN2s are treated as one when adding the min inputs of the Priority 1 set.

Figure 11 Boiler System Response 4
(2) KN2s, (3) KN6s

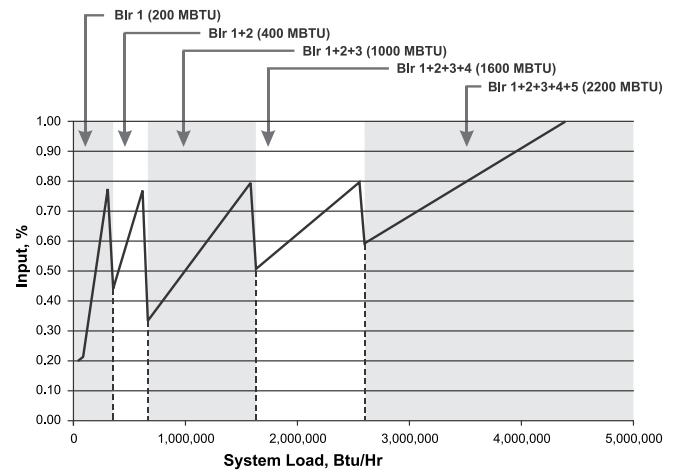

The above Boiler System Response 4 graph illustrates another system where 80% is used as the MOD-MAX clamp.

In summary, the system should be tuned using the boiler selection charts and the MOD-MAX value so that boilers are brought on and fired in their respective efficiency curve while maintaining continuity in BTUs. Since selecting the Priority 1 boiler is integral to the fault tolerance of the system, it is important to note any discontinuities in BTUs if a Priority 1 boiler fails when multiple Priority 1 boilers are used.

Mixed System Type 2: Condensing / Non-Condensing

This mixed system may also have mixed boilers with differing sizes as outlined in the Mixed System Type 1: High System Turndown section. In the following examples condensing high mass boilers will be used with non-condensing low mass boilers. The reason for creating a mixed system is primarily to control the system cost.

For the examples, the RBI FIII series water heaters will be used. These boilers are non-Condensing, fully modulating, low mass, and HeatNet compatible. Also, consider the SMITH series 28 with the HeatNet option in the Priority 2 set.

Figure 12 Mixed Boiler System

System MMBTU	Effective Turndown	MOD MAX	Priority 1 KN 5:1	Priority 2 MB/MW 3:1
3.45	28:01:00	62%	KN6, KN6	FIII 750, 750, 750
4.2	35:01:00	76%	KN6, KN6	FIII 1000, 1000, 1000
2.3	29:01:00	62%	KN4, KN4	FIII 500, 500, 500

Figure 13 Mixed Boilers: Example: Condensing/Non-Condensing

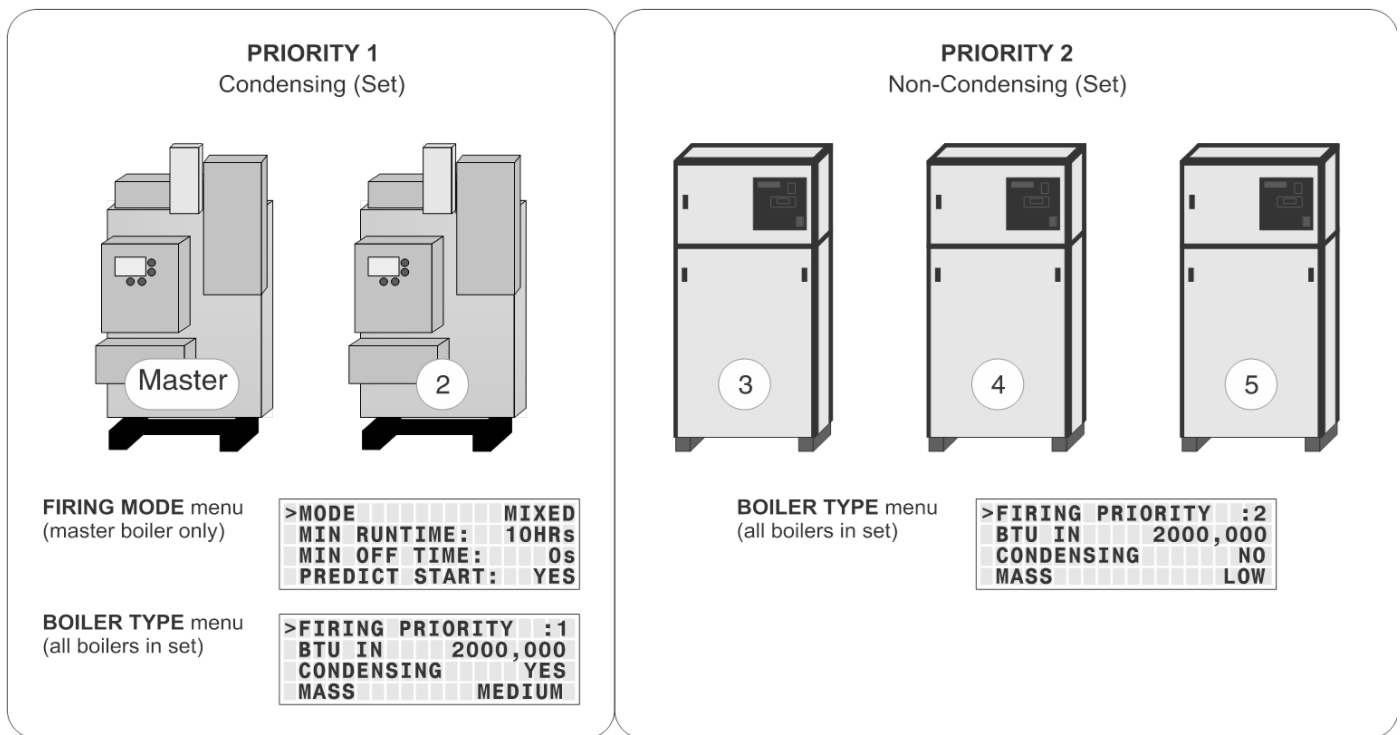

Figure 14 FIII Boiler Btu Chart (MBH)

MB/MW	500	750	1000	1250	1500	1750
Max Input	500	750	1M	1.25M	1.5M	1.75M
Min Input 3:1	166	250	333	416	500	583
Mod Max 80%	400	600	800	1	1.2M	1.4M
Mod Max 70%	350	525	700	875	1.1M	1.2M
Mod Max 60%	300	450	600	750	900	1.1M
Mod Max 50%	250	375	500	625	750	875M

Using the boiler charts and the examples used in: Mixed System Type 1: High System Turndown, a mixed hybrid boiler system can be designed. The Priority 1 boilers should be setup so as to keep the non-condensing boilers from seeing return water temperatures of less than 140F to ensure a long heat exchanger life.

Normally, the Priority 1 boilers will fire first. Once all the Priority 1 boilers are firing, the next boiler to fire (after the ADD BOILER timer expires) would be the Priority 2 (non-condensing). If the return water temperature has not come up to ~140F, the non-condensing boilers could fire in a condensing mode. The ADD BOILER delay timer would have to be set to a long enough period to ensure this does

not happen. Even then, the load may be too great. The following note will explain an alternative way (not depending on the ADD BOILER DELAY) to keep non-condensing boilers from firing in a condensing mode.

When running with a remote BMS setpoint, care must be taken that an Outside Air reset setpoint (or other setpoint) sent by the BMS is not set too low. If the BMS system is controlling the setpoint close to the condensing temperature, the return water temperature may never rise sufficiently to keep boilers out of a condensing mode. HeatNet online is a good way to monitor this scenario if suspected.

NOTE:

If the firmware version for a HeatNet V2 board is at least 3.47(or a version 3 board), the non-condensing boiler may hold itself off from being added to the HeatNet Master’s available to fire list. This would effectively keep the non-condensing boiler from firing in a condensing mode, but as a result, may not satisfy the system setpoint.

In order to use this feature, the version 2 board would need to monitor the system or local return temperature. This can be done locally by setting SETUP: AUX FUNCTIONS: HEAT EXCHNAGER: TEMP DISAB: RETURN if the there is no pump/valve limiting flow continuously through the boiler. If there is a pump/valve limiting the flow through the boiler, the SETUP: AUX FUNCTIONS: HEAT EXCHNAGER: TEMP DISAB: SYS RET needs to be set. Then the Master boiler needs to set SETUP: AUX FUNCTIONS: HEAT EXCHNAGER: SEND RETURN: to which of its return temperatures it would send to all boilers. These include the Local Return temperature or the System Return temperature.

The Member’s menu “SETUP: AUX FUNCTIONS: HEAT EXCHNAGER: TEMP DISAB:” if set to RETURN or SYS RET, will force the boiler to become unavailable to HeatNet when the SETUP: AUX FUNCTIONS: HEAT EXCHNAGER: TEMP < 140F. This value is adjustable to 135F if a forced air fan is used. When the SYS RET or RETURN temperature is <140F the boiler responds to a HeatNet Master’s request as “unavailable”. As soon as the return temperature reaches 140F, the boiler will respond to the Master’s request that it is available to fire.

If the Master boiler is a version 2 board, the Master will always transmit its Local Return temperature to all boilers. If the Master is set to Priority 1 and all other non-condensing boilers are set to Priority 2, the Master should always remain on if there is a call for heat. This requires that the Priority 1 boiler be set up to start first and stop last. Using this method should always send a valid return temperature to the Member boilers. This method can also be used with a version 3 board, but a system return sensor is preferred.

*When this condition is in effect, the STATUS * screen will indicate “blr offline”. While the boiler is in this “not available” state, it can still be fired locally and failsafe is still available.*

SETUP: AUX FUNCTIONS:HEAT EXCHANGER:SEND RETURN:

- OFF The Master sends its return temperature to all boilers
- RETURN The Master sends its return temperature to all boilers
- SYS RET The Master sends the system return temperature to all boilers

SETUP:AUX FUNCTIONS:HEAT EXCHANGER:LOW TEMP:

- OFF No check is made to the return temperature – boiler remains online
- RETURN Uses the boilers own return sensor (No pump /valve present)
- SYS RETURN Uses the System Return temp received from the Master Boiler (its Local or System Return).

SETUP:AUX FUNCTIONS:HEAT EXCHANGER:TEMP < 140F

Adjustable threshold temperature below which the boiler will take itself offline.

(1) degree F of hysteresis is provided so as to not toggle offline<-to->online at the threshold temp.

Since the FIII boiler is non-condensing, the efficiency vs. input is relatively flat. The MOD MAX value will not have the same impact if the FIII non-condensing boilers were placed in the Priority 1 set.

KN Boiler Btu Chart (MBH)

	KN2	KN4	KN6	KN10	KN20	KN30
Max Input	200	400	600	1MM	2M	3M
Min Input 5:1	40	80	120	200M	400	600
Mod Max 80%	160	320	480	800M	1.6M	2.4M
Mod Max 70%	140	280	420	700M	1.4M	2.1M
Mod Max 60%	120	240	360	600M	1.2M	1.8M
Mod Max 50%	100	200	300	500	1M	1.5M

Base Loading, Relay Control

The control has the ability to control (1) base load boiler using the K8 Relay contacts on J4 pins 2 & 6. In order to connect to this plug, (2) wires with pins are required and inserted in J4. Base Loading via relay requires these (2) flying leads (loose wires available from the factory) to be inserted into J4, pins 2 & 6. These (2) wires then make up the Normally Open contacts. This feature also can be used on Master or Member boilers. The solid state relay K8, with contact connections on J4.2 & J4.6 has a rating of: **0.1 to 1 Amp.**

If the base load boiler is of the modulating type, a 4-20mA signal is also provided on J4 pins 1 and 5. Jumper shunt JS1 will then need to be set to 4-20mA position. Two additional wires (available from the factory) will need to be added to the J4 pins at 1 & 5. Pin 1 is the + output of the 4-20mA transmitter, and pin 5 is the - output. This modulating control signal is used to modulate the base load boiler along with the HeatNet boilers in parallel. The ADAPTIVE MOD does not function in lowering the modulation rate when the base load boiler is added. The PID will adapt to the newly fired base load boiler and lower its modulation rate when the increase in water temperature is observed.

Figure 15 Base loading with KN boilers

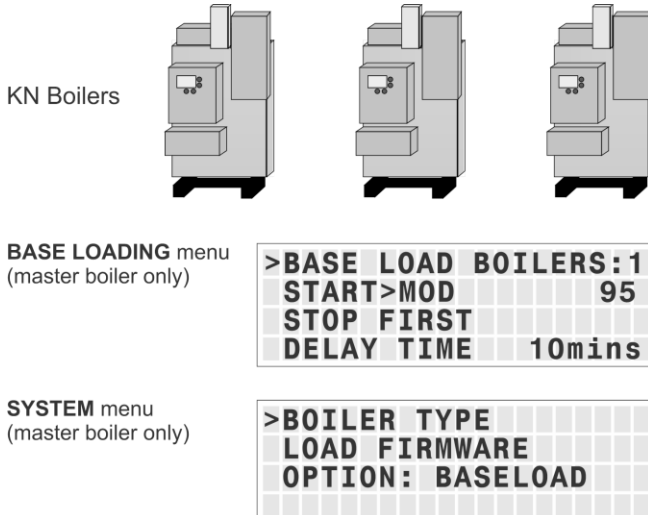

Enable the base load feature by setting:

ADVANCED SETUP:SYSTEM:OPTION to BASE LOAD. This setting the OPTION Relay to be used as control for a Base Load Boiler.

1. **ADVANCED SETUP:SYSTEM:OPTION to BASE LOAD.** This setting the OPTION Relay to be used as control for a Base Load Boiler.
2. The **ADVANCED SETUP:BASE LOAD BOILERS: BASE LOAD BOILERS:** to 1. Currently allows (1) base load boiler.
3. The **START & STOP** qualifier condition to the method discussed below.
4. The **DELAY TIME** to the amount of time required after the start qualifier condition has been met to start the boiler.

If a MINIMUM OFF time of the Base Load boiler is needed, the Base Load boiler will share the MIN OFF TIME of the boiler controlling it. If the base load boiler was running and shuts off, the MIN OFF TIME will need to expire before the boiler can start again. Once this time expires, the DELAY TIME also needs to expire to start the boiler. This will help in minimizing short cycle conditions and can be set at: **ADVANCED SETUP:FIRING MODE: MODE:MIN OFF TIME.**

Preferred:

A modulating base load boiler that can accept a 4-20mA control signal such as the SMITH 28 series (and is preferred) or a non-modulating base load boiler that is sized correctly to the H-Net boilers. The Smith 28 series also has a HeatNet option. A 135 ohm input for the base load boiler will need a converter from 4-20mA to 135 ohm .

<http://www.smithboiler.com/>

If the base load boiler is not of the modulating type, stopping the Base Load boiler will require that the size of the Base Load boiler in BTUs to be known relative to the HeatNet boilers. Boiler selection is ideally; having more total BTUs in the HeatNet boilers than total BTUs of the Base Load boiler. This will prevent short cycling. Example: (4) 2 million BTU HeatNet boilers = 8 million BTUs and (1) 6 million BTU Base Load boiler.

When all (4) HeatNet boilers are running @ 95%, the Base Load boiler is called on (demand is approx. 8 million BTUs). As the Base load boiler comes on it introduces 6 million BTUs and the HeatNet boilers modulate down to 25% for a total output of 2 million BTUs and running at high efficiency. The HeatNet boilers can now modulate to the load from 1.6 million BTUs (20% mod) to another 8 million BTUs.

Not Preferred:

Example of having a larger Base Load boiler that is not of the modulating type: If there is a 6 Million BTU Base Load boiler running with (3) 2 million BTU HeatNet boilers, a short cycling situation will arise when the (3) 2 million BTU boilers are running @ 95% and the Base Load boiler is called on. At this point there is a need for approximately 6 million BTUs. The (3) smaller boilers will then modulate down to low fire. At this point, the (3) smaller boilers need to shut off or the Base load boiler would need to shut off.

There is no overlap. A selection for stopping the boiler now needs to be determined. Setting the Stop qualifier; Modulation to 40% or a low fire rate will shut the Base Load boiler off and allow the (3) smaller boilers to modulate up again (short cycle of the Base Load boiler; Use the Delay Timer and Min OFF timer). The Stop qualifier; OA T > xxF may also be used if the system design temperature is known. Then let the Base Load boiler cycle off of its limits, whether a 2 stage, Hi/Lo, or modulating boiler. The default setting is for the Base Load boiler to stop first once the water temperature *exceeds the top of the heating band*.

Figure 16 Base loading relay

1. First ensure that the ADVANCED SETUP:SYSTEM:OPTION: is set to BASE LOAD. The Base Load Relay (K8) will not be enabled/used unless this is selected.
2. Now, The ADVANCED SETUP:BASE LOAD:BASE LOAD BOILERS: must be set to 1.
3. When the START condition in the BASE LOAD BOILERS menu is met, the K8 relay will close. But, only when the DELAY TIME under the BASE LOAD BOILERS menu expires.

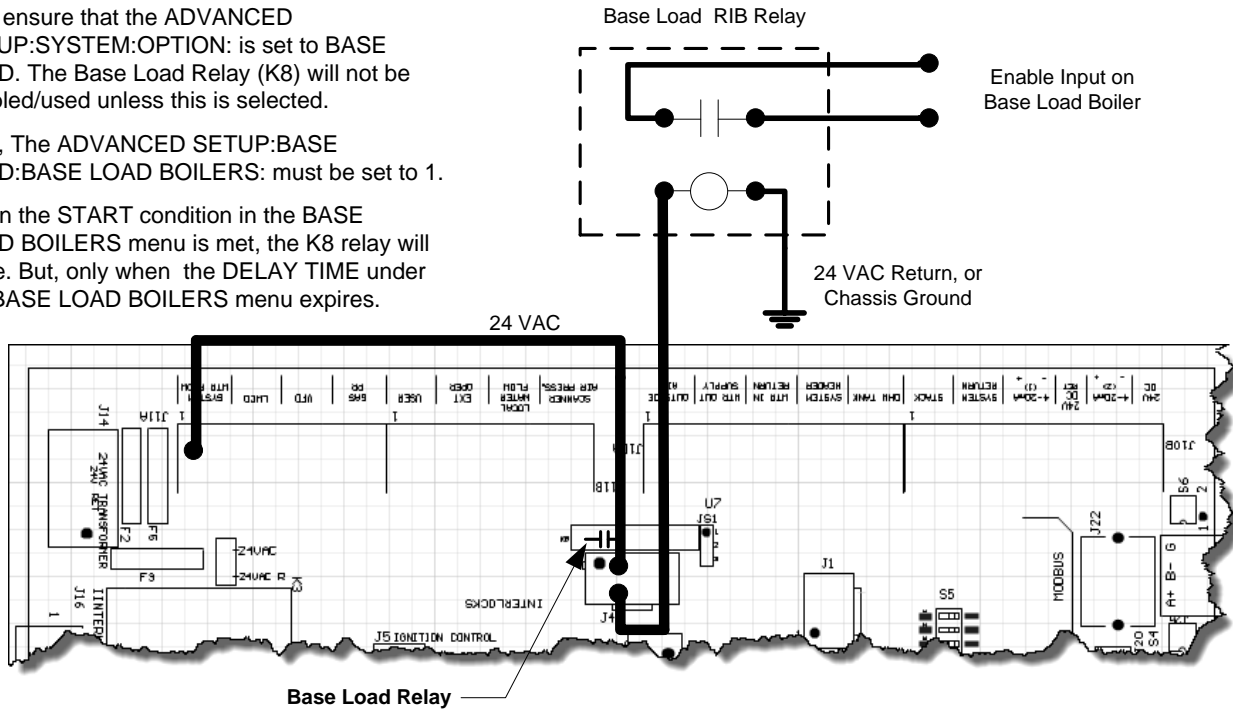

Setting up base loading

The base load boiler is controlled using a set of contacts to enable it (location J4). Enabling/Disabling this relay contact can be done using any combination of (3) qualifiers to start the boiler and (4) to stop the boiler. These qualifiers are:

1. Modulation %:

- a. **START menu item:** The relay contact will close when the MOD % from the Master boiler exceeds this value. **ADVANCE SETUP:BASE LOADING: START>MOD**
- b. **STOP menu item:** The relay contact will open when the MOD % from the Master boiler falls below this value. **ADVANCE SETUP:BASE LOADING: STOP<MOD**

NOTICE

If the **START>MOD** value is set to a value higher than the **ADVANCED SETUP:MOD-MAX**: **all boilers** will be firing before this modulation rate is reached. This will ensure that all available boilers are firing before the base load boiler relay is enabled.

- c. Setting the : **STOP<MOD** to a % value slightly above the min fire rate % of the system will ensure that the base load boiler will stop before the first condensing boiler stops. This is due to the Modulation rate being close to the min modulation rate before the water temperature exceeds the top of the heating band.

2. Outside Air Temperature:

- a. **START menu item:** The relay contact will close to enable the boiler when the OA T read from the Outside Air Temperature sensor (if Equipped) falls below this temperature. **ADVANCE SETUP:BASE LOADING: START< OA T**
- b. **STOP menu item:** The relay contact will open to disable the boiler when the OA T read from the Outside Air Temperature sensor (if equipped) rises above this value. **ADVANCE SETUP:BASE LOADING: STOP> OA T**

NOTICE

If the OA T qualifier is used as the Start and Stop qualifier, ensure that there is at least a few degrees difference for hysteresis.

3. Return Water Temperature

- a. **START menu item:** The relay contact will close to enable the boiler when the RET read from the Return Water Temperature sensor (if Equipped) falls below this temperature. **ADVANCE SETUP:BASE LOADING: START> RET**
- b. **STOP menu item:** The relay contact will open to disable the boiler when the RET temperature read from the Return Water Temperature sensor (if Equipped) rises above this temperature. **ADVANCE SETUP:BASE LOADING: STOP< RET**

4. FIRST:

- a. **STOP menu item:** The relay contact will open to disable the boiler when the temperature exceeds the heating band. This gives the result of stopping the Base Load boiler First. Default setting.

Delay time

The DELAY TIME is also included to hold off starting the boiler until the delay time is met. Once the start condition qualifier term is met, the DELAY TIME will start counting down. When the time expires, the base load relay contacts will close. **ADVANCE SETUP:BASE LOADING:DELAY TIME**. It is adjustable in a range of: 0 to 60 minutes.

Base Load Failsafe

If :

- 1) There are no boilers available to fire (offline or faulted).
- 2) There are no boilers in local override.
- 3) There is a call for heat.

The J4 Base Load relay will close.

If a boiler becomes available and needs to fire, the Base Load boiler will remain firing until the temperature exceeds the band. This is provided to keep the system from entering a no heat situation.

Heating Control Methods

An overview of the (5) methods for controlling the KN series boiler are presented here. They are outlined in more detail at the end of this section.

Heating Method 1

The first method is to use the KN Series boiler in its stand-alone modulating method. This method uses a PID algorithm to maintain a setpoint and is enabled using the HEAT DEMAND input. Closing a relay contact or switch across the HEAT DEMAND input will cause the Master boiler to control all member boilers using H-Net.

A member boiler may also be controlled by the HEAT DEMAND input (LOCAL mode). The member boiler will then ignore commands from the Master and maintain its LOCAL SETPOINT at the supply sensor.

Heating Method 2

The second method is to view the KN boiler as two separate boilers or as a HIGH/LOW boiler using T1 & T2.

Heating Method 3

The third method is to allow a remote 4-20 ma or 0-10 VDC signal to control the firing rate (modulation) of the boiler using the 4-20ma input, along with the 4-20ma REMOTE ENABLE input.

Heating Method 4

The fourth method turns the boiler ON and OFF @ 100% modulation using the AA terminal.

Heating Method 5

The fifth method uses an RS485 digital communications cable with the MODBUS protocol. The boiler is controlled by writing and reading registers using MODBUS commands. A bridge module may also be used to convert BACnet or LonWorks protocols to MODBUS.

NOTICE

Short cycling may occur when a firing rate is sent to a member boiler that would cause the supply temperature to raise high enough to trip the operating limit (low flow rate). After the supply temperature falls, the boiler would restart and the process may continue. A member boiler would use its supply (outlet) sensor to protect itself from short cycling by limiting the firing rate coming from the Master. This occurs in the event that the member's supply temperature increases above the (OPERATE LIMIT- OPERATE LIMIT BAND).

Operating Limit

When the master boiler or an external control input is used to control a member boiler (i.e. AA, T1-T2, 4-20ma, H-Net), a software operating limit on the member boiler will be used to limit the maximum output of the member boiler. This operating limit can be adjusted in the **SETUP:SETPOINTS:OPERATING LIMIT**.

There is also an associated operating limit band that must be set in conjunction with the operating limit to help prevent this LIMIT from being reached. Its purpose, is to limit the output of the boiler as it approaches the operating limit. If the band is set to 10 degrees, then for every degree that it approaches the operating limit, the maximum output will be lessened by 10%. With a band of 20 degrees, for every degree that it approaches the band, the maximum output will be lessened by 5%. You can think of this operating limit as a smart aquastat which prevents the High Limit from tripping. This method minimizes boiler short cycling when using external inputs. The minimum setting is 1 degree and effectively turns the limit band OFF. The default setting is 20F.

Input Priorities

The KN-Series **control inputs are prioritized** so that multiple levels of external control can be employed at the same time. This means that if we are firing the boiler with a low Priority input and a higher Priority input is called for, the boiler will now fire at the higher Priority input. When the high Priority input is removed, the boiler will revert back to the lower Priority input that is still being called.

Priority 1

The AA terminal has absolute control, and if used, will always fire the boiler at 100% output, regardless of any other input. The 4-20mA input may be raised to this Priority using **ADVANCED SETUP: 4-20mA INPUT:CHANNEL MODE:PRIORITY**.

Priority 2

The HEAT DEMAND input is the next, and provides the means to operate the boiler in LOCAL MODE when an external control is not present, has failed, or needs to be enabled or disabled. A member can override the H-Net commands using this input.

Priority 3

If a HeatNet (H-Net) Network cable is connected between boilers, and one is configured as a MASTER (requires HEADER sensor), then the MEMBER boilers will be controlled over the network by the MASTER.

Priority 4

The 4-20ma/0-10VDC input in tandem with the 4-20ma REMOTE ENABLE input is next. Any signal over 4.02ma or 2.01VDC will start and operate the boiler if the REMOTE ENABLE is closed.

Priority 5

The lowest Priority is using the boiler as (2) stages HIGH/LOW. These are the T1 and T2 inputs.

Each of these control methods will now be explained in more detail:

Heating Method 1 HEAT DEMAND

Closing a relay contact, switch, or jumper across the HEAT DEMAND input will enable this method. This method allows operation as a setpoint control. As a setpoint control, the Master (defined by having a common system supply header sensor), on the H-Net network can command the boiler fire rate of all Member boilers. The Master can call as many boilers that it has available (boilers are auto-detected over the H-Net cable by the Master) to meet its **SYSTEM SETPOINT**. The H-Net cable must be connected and will cause the amber light on the communications board to flash. The amber light indicates an H-Net master is broadcasting control information and a system heartbeat.

The AA terminal, the FAILSAFE mode active, 4-20ma at PRIORITY:HIGHEST, and the HEAT DEMAND input (LOCAL) on a Member, are the only inputs that will override the H-Net control.

Figure 17 Heat demand input

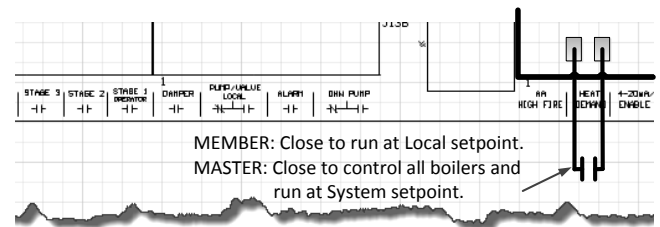

Master boiler

The MASTER boiler controls the system using a PID algorithm. Once the boiler is started, a PID algorithm is used to produce a modulation percentage value from 0-100%. This percentage is converted to a PWM, (P)ulse (W)idth (M)odulation signal by each boiler. The temperature of the water is maintained by sending this PWM signal to the Variable Frequency Drive, which in turn controls the blower motor. Since the main fuel valve is air-fuel coupled to the blower, the speed of the blower provides the firing rate.

Member boiler(s)

A Member (lacking a common system supply header sensor) boiler may also be controlled by the HEAT DEMAND input (LOCAL mode). The member boiler will then ignore commands from the Master and maintain its own LOCAL SETPOINT at its supply sensor. This can be viewed as a manual override on a member boiler. Be sure to observe the use of the proper use of a Common System Damper (See: AUXILIARY FUNCTION OPTIONS section) and any system pumps or system common interlocks.

Features of the HEAT DEMAND input include:

1. The control is designed to **predict** when to start and stop the boiler and keep the setpoint in, or as close to the control band as possible. If PREDICTIVE START is enabled, the boiler may start when it is in the band and not below it. This will help to maintain a more accurate temperature relative to the setpoint. See also: ADVANCED SETUP:FIRING MODE:PRDICTIVE START: to disable this feature.
2. The control can also use the Outdoor Reset feature. This feature allows the setpoint to be changed automatically based on the outside air temperature. If this feature is used, the control input: OR OVR (OUTDOOR RESET OVERRIDE), can be used to override the Outdoor Reset feature and run from the local setpoint. A contact closure on the 'AA' input can also override this method.
3. The 4-20ma setpoint control function works in conjunction with this mode. This function translates a

4-20ma control signal to a setpoint mapped between 50F and 220F. These (2) temperatures are adjustable to provide a setpoint range. The minimum start current is also adjustable between 3.71 and 5ma. The setpoint control feature is used in conjunction with the REMOTE ENABLE input on J12A. This feature is enabled in the SETPOINTS menu as:

SETPT SOURCE 4-20ma

- There is also support for a common system damper, Heat Exchanger support, and starting the Master first for common venting. For an overview of each of the menu settings see: **DEFAULT SETTINGS** section.

Heating Method 2 STAGE Control T1-T2

The boiler can also be operated in 2 separate stages using the inputs T1 and T2 inputs. Its intended use is with an external stage controller with no analog or modulation outputs.

Closing only one of these contacts tells the boiler to operate at MINIMUM FIRE.

- Closing the other contact will fire the boiler at MAXIMUM output (the same rate as closing the AA input).

Figure 18 Stage control input

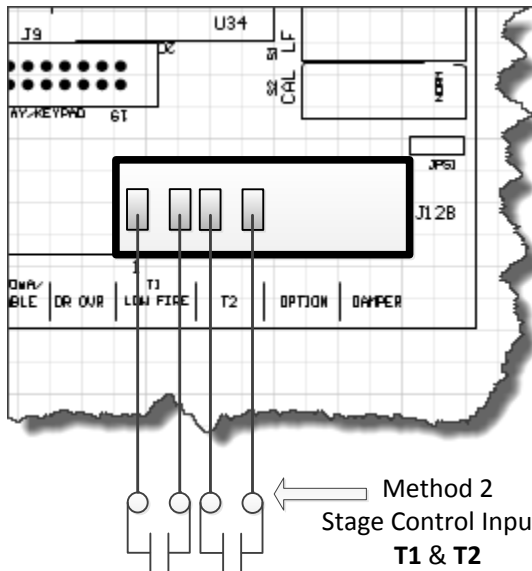

NOTICE The maximum output of the boiler is based on the MAX VFD setting in the calibration mode and not the nameplate rating.

The AA, HEAT DEMAND (LOCAL) input, the H-Net, the 4-20ma input will all override the stage control inputs.

Heating Method 3 4-20ma Control

Placing a current source between the + and - 4-20ma inputs will allow remote control of the boilers firing rate. An adjustable starting mA current signal here will start and then fire the boiler at the minimum fire rate. See: **ADVANCED SETUP:4-20mA INPUT: CHANNEL MODE.**

See section OPTIONAL FEATURES Using the 4-20ma input for extensive detail.

A 20ma signal will fire the boiler at the maximum firing rate. The input current signal is viewed as a percentage to the boiler from 0 to 100% (0-20mA). This means that a 20% (4mA) input signal is required to start the boiler, but since the boiler is classified as having example:4:1 turn down ratio, the boiler can only be fired as low as 25% of output. Any signal between 20% and 25 %, will fire the boiler at the minimum fire rate. If the MINIMUM setting of the boiler is set above the example: 4:1 turndown of 25% (such as 33%), a control signal change between 25% and 33% will not change the boilers firing rate. Once the control signal rises above the MINIMUM fire rate, the control signal will then affect control of the boilers fire rate.

The AA terminal, the HEAT DEMAND, and the H-Net NETWORK are the only inputs that will override the 4-20ma input.

Heating Method 4 AA Input

HIGH FIRE input Control: The AA input will fire the boiler at HIGH fire (maximum output of the boiler). No other inputs can override this input.

Figure 19 AA — High fire input

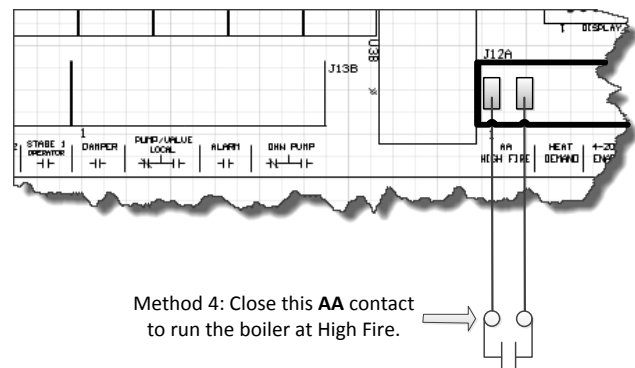

Heating Method 5 MODBUS communications

The fifth method uses an RS485 digital communications cable with the MODBUS protocol to control the boiler using the H-Net network. The Boiler or Boiler network will run as in Method 1, but instead of the HEAT DEMAND input, a software form of the HEAT DEMAND input is used (40001: Boiler/System Enable/Disable). See: MODBUS COMMUNICATIONS section.

Figure 20 MODBUS connections

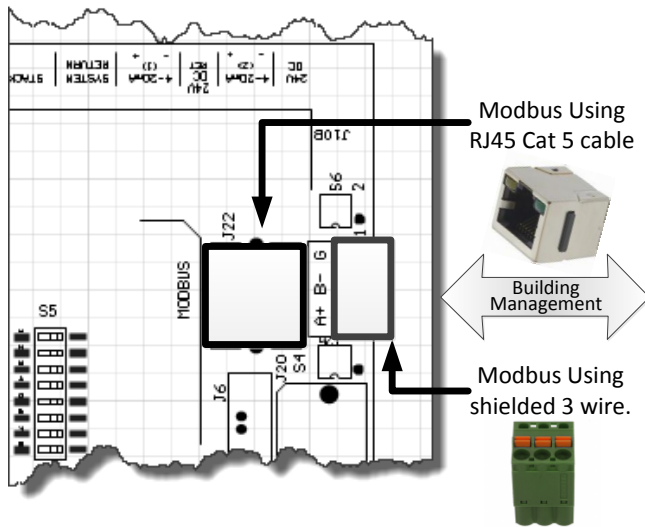

The System Setpoint Timer also needs to be loaded periodically to allow the H-Net system to fallback to Method 1 in the event communications is lost from the Building Management System (BMS).

This feature can be turned off in **ADVANCED SETUP: COMMUNICATIONS: SETPOINT TIMER: OFF**. If the setpoint timer feature is set to **ON**, the **ADVANCED SETUP: COMMUNICATIONS: SETPOINT TIME** may be set to a time that allows any write to a MODBUS register to reset the setpoint timer as long as it occurs within that time. This will reset the setpoint timer without writing the setpoint timer register. So, periodically writing the setpoint register will automatically reset the setpoint timer as long as the write occurs within that time window.

Processor option

An optional BACnet or LonWorks bridge module can be used to connect the MODBUS network to a BACnet or LonWorks network.

Figure 21 Processor bridge module option

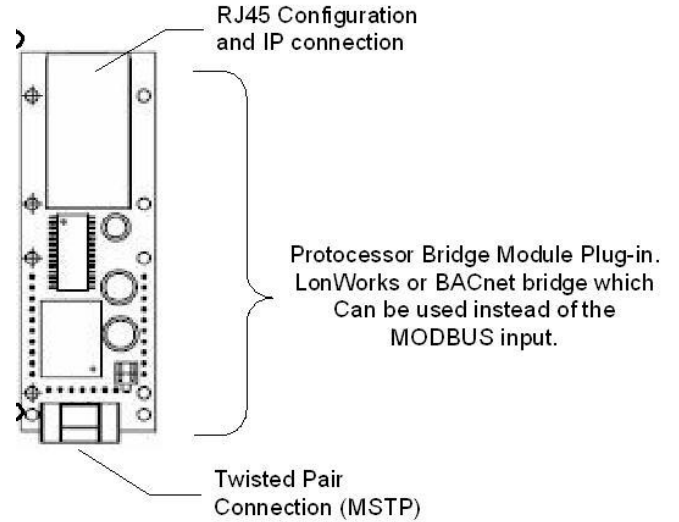

This method allows enabling and disabling the boiler or H-Net system, changing setpoints, reading boiler(s) status, or temperatures remotely using digital commands. See the section: *MODBUS Communications*.

Using the 4-20ma input (OPTIONAL)

The 4-20ma input is designed to operate per the ISA-50.1 standard. It will support Type 2, Type 3, and Type 4 Transmitter/Receiver circuits.

The Type 2 and Type 3 circuit may use the supplied +24VDC and 24VDC RET connections (J10B) to power a remote transmitter. The -ma terminal will need to have a jumper connected to the adjacent 24VDC RET terminal to reference the signal ground.

With the type 4 configuration, multiple boilers (up to 5), may be connected in series using the -ma +ma -ma +ma scheme (no jumper to 24VDC RET). This allows one 4-20ma transmitter to control multiple boilers. A free-floating 250 ohm resistor is viewed by the BMS (or external control's) 4-20ma transmitter across the + and -4-20ma terminals with this method.

Figure 22 4-20ma connections

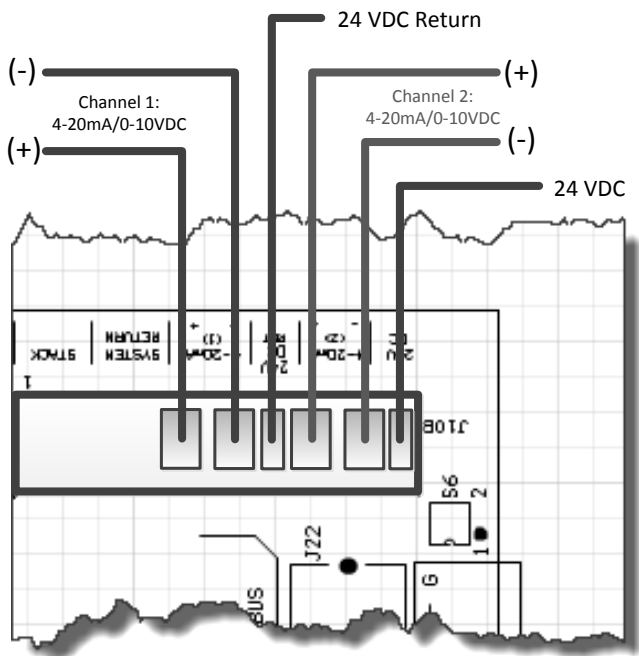
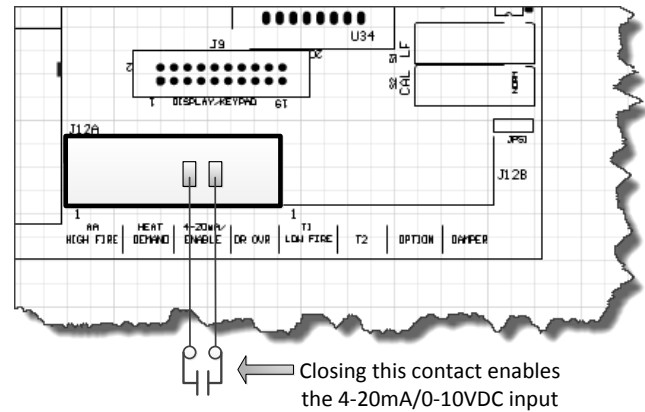

Figure 23 4-20ma enable connection



The 4-20 ma input uses a 250 ohm sense resistor to convert the current to a voltage from 1 to 5 volts DC for the control to use. For this reason, a 1-5 VDC control voltage may also be used across the 4-20mA +/- input, but it still needs to supply the necessary current, i.e. 20mA. This resistor is located on the bottom side of the control board. When a 4.02 ma signal is sensed, the boiler will initiate a start sequence and fire the boiler at its minimum setting if the REMOTE ENABLE input is closed. This is typically 25% of the boilers output (4:1 turndown).

If the dip switch S6 is set to the 0-10 position (UP) See: Figure 31, the 4-20mA input will accept a 0-10 VDC signal. The channel will also need to be setup in the menu: **ADVANCED SETUP: 4-20ma INPUT: CHANNEL MODE**. The operating range will be from 2-10 VDC or twice what was previously stated for the 1-5 VDC functionality. **To convert a 0-10VDC signal to mA, divide by 2510 (ohms).**

NOTE: Due to the inability of control voltage methods (1-5, 2-10 VDC) to reject noise and compensate for line loss, the use of the 4-20mA control current is recommended. The control voltage methods may be less expensive, but are the least stable. If using a 0-10VDC control signal, a source current of 5mA is required.

If using a remote panel with a relay and a 4-20 ma transmitter for operation, connect the 4-20ma transmitter output from the remote panel to the member boilers using the floating 250 ohm method (type 4). The relay contacts on the remote panel will then be connected to the associated 4-20ma REMOTE ENABLE inputs on the associated boiler(s).

NOTICE

For non Ametek blowers, the minimum setting of the boiler is calibrated so that the minimum PWM signal to control the Blower motor is 20%. The VFD to blower motor operates with a control signal from 20% - 80% Pulse Width Modulation. This PWM signal to the VFD can be measured using a multimeter. It is a 0–10volt square wave signal at 110 Hertz. A 20% modulation signal will read 2.0 VDC, and an 80% modulation signal will read 8.0 VDC on an RMS multimeter. See Figure 36, page 56.

For **Ametek** Blowers, the minimum signal to control the blower will be less than 20%, but the display % will be equal to the turndown % of the boiler. Also, the signal sent to the Ametek blower is twice that of non Ametek blowers, so the VDC reading will need to be divided by (2) to get the modulation % sent to the Blower. The Ametek blower also has a menu located at: **ADVANCED SETUP:BLOWER SETTINGS**. This menu allows the Acceleration, Deceleration, and Soft Start Values to be set for proper operation of the Blower.

For direct fire applications, the 0-10 volt control signal is proportional to the output. Such that: 1 volt will track linearly by 10%. So, 1v=10%, 2v=20%, 3v=30%, 4v=40%... The control signal will still be limited by the turndown and the 4-20mA INPUT menu. This means that the 1v signal will have no effect on a 5:1, 20% boiler. A ~2v signal will start the 5:1 boiler.

Setpoint Control functionality can be implemented remotely using the 4-20mA input. This function translates a 4 to 20ma control signal to a setpoint mapped from 50F to 220F. The feature is enabled in the SETPOINTS menu as: **SETUP: SETPOINTS:SETPT SOURCE 4-20ma**.

ADVANCED SETUP:4-20ma INPUT:CHANNEL MODE. Also, when selecting; SETUP:SETPOINTS:SETPT SOURCE and selecting 4-20ma, the 4-20ma INPUT menu will be automatically entered.

You may now select the current at which the boiler will start. It is adjustable from 3.7ma to 5ma. Hysteresis of .1ma is always in effect. So, if the starting ma = 4.10ma the boiler will start when the control current applied achieves this value of 4.10ma. The boiler must drop .1ma below this to turn OFF, in this example 4.00ma. This hysteresis value is not adjustable.

When using the 4-20ma setpoint control, a band may now be set at which the 4-20ma signal will operate over. The lower setpoint is defined as 4ma SETPOINT and the upper setpoint is defined as 20ma SETPOINT. The 4ma SETPOINT is

linked to the BOILER START x.xxma where this starting current is the lower setpoint. So, if we set the 4ma SETPOINT to 130F and the 20ma SETPOINT at 180F we will have established the band. Once a starting control current of BOILER START 4.1mA is applied, and the 4-20 REMOTE ENABLE INPUT is closed, the boiler will start and the setpoint will be set to 130F. If a control current of 10ma is applied the boiler will track on a linear slope towards the 20ma SETPOINT settling at a SETPOINT of ~149F. As the current increases to 20ma, the SETPOINT will indicate 180F. The Default setting is 4ma SETPOINT: 50F, and 20ma SETPOINT 220F for backwards compatibility with the older version. NOTE: anytime a new firmware version is uploaded to the control, these values return these defaults.

NOTICE

Anytime a new firmware version is uploaded to the control, these values return to these defaults.

If using the direct modulation mode by applying a 4-20ma current, only the BOILER START x.xx setting applies.

The 4-20 mA input can be set to HIGH PRIORITY. This is done in menu: **ADVANCED SETUP:4-20mA INPUT:CHANNEL MODE**. This allows a member boiler to be taken offline and directly modulated by an external control. If the Master is using it for heating and the 4-20mA is set to HIGH PRIORITY, an external control can now output a 4-20mA signal which will take over the boiler's fire rate. This is typically used for DHW control.

Setpoint Priorities

Changing the setpoint can be done in many ways. If a higher level setpoint control is lost, the next level setpoint control is used until the System Setpoint is loaded. The setpoints are prioritized in the following order:

1. 0-10V, 4-20Ma setpoint Control
2. BMS, Modbus Setpoint
3. Outdoor Reset Setpoint
4. Menu's System Setpoint

Any Setbacks that are active are then applied.

Circulator Pump Options

There are provisions for a system pump(s) and a local pump. This is to allow for primary/secondary loop configurations. The system circulator pump is implemented using the K4, K13 RELAY and normally open contacts at J13 SYSTEM PUMP 1 and SYSTEM PUMP 2.

NOTICE The pumps require motor contactors to isolate the on-board relay contacts. The on-board relays should never be used to energize large pumps directly. **Figure 25** illustrates the connections without contactors for illustrative purpose.

Figure 24 System Pump connections

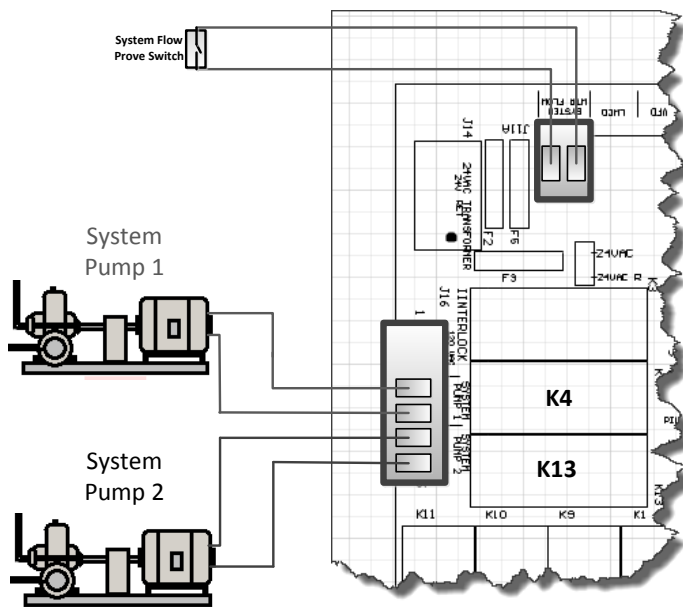
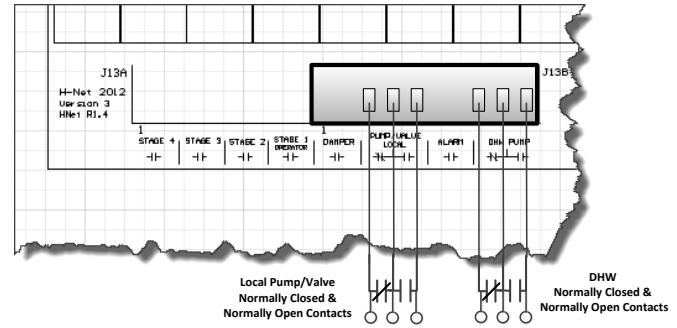

Figure 25 Local & DHW Pump connections



The **system circulator pump** is supported by (2) modes and special features.

1. The first mode will allow the circulator pump to remain on, unless the control’s outside high air temperature setting has been met when using **OUTDOOR AIR RESET**.
2. The second mode will allow the circulator pump to be turned on whenever there is a call for heat (any control input). This mode will stop the circulator pump when the call for heat is lost and the pump post purge time has been satisfied.

The summer pump jog is a special feature that can be selected when the system is in summer shutdown (**OUTDOOR RESET**). The jog allows the system circulator pump(s) and the local pump to run for the system pump purge time once a week. It can be set to any day of the week and will occur at 12:01 AM. If (2) system pumps are present, and after the first pump finishes its post purge, the second one will start and the first one will stop.

The system flow proving switch is implemented using **SPARE 3/System Water Flow** on J11A. If a flow switch is connected to the **WTR FLW** interlock, the HeatNet control will wait up to 10 seconds to prove flow. If flow is interrupted after it has been established, an error will be displayed and the boiler will cycle OFF. As long as there is a call for heat, every 10 minutes the circulator pump will try to re-establish flow and start the boiler again.

When (2) system pumps are present and flow is not established or is lost (2) things will occur to try and keep heat in the system.

1. **When first starting a system:** If after a 10 second wait to establish flow has failed, the first pump will change to the second pump. The second pump will now try to establish flow for 10 more seconds. If the second pump fails to establish flow, the HeatNet control waits *10 minutes*. After the 10 minutes has expired, the control now starts with the second pump and attempts to prove flow for 10 more seconds. If flow does not

prove, the control changes to the first pump and attempts to prove flow. This cycle will continue indefinitely until flow is established. **If flow is lost while running:** this process is also used in an attempt to re-establish flow.

2. If PUMP ROTATION is set to PMP HRS the PUMP ROTATION will be temporarily set to SYS HRS. This is to prevent re-starting the failed pump due to its runtime hours. Setting the PUMP ROTATION to SYS HRS will allow a retry of the failed pump after the rotation hours has expired. Power cycling of the boiler or using the PUMP ROTATION menu will revert back to PUMP ROTATION = PMP HRS if this was the original setting.

For **system pump modulation** a 0-10Vdc control signal output is provided at J4.3 (signal) and J4.7 (ground). This signal is output by the Master boiler as a percent function of the number of boilers running and can be used to set the speed of a System Pump using a Variable Frequency Drive. Two wires are required and need to be inserted into the J4.3 and J4.7 positions to access this signal.

Note: This signal has a step response and is not linear to the system or boiler's input firing rate.

The output signal is proportionally mapped to % using the equation:

$$\%VFD = (\text{boilers running}/\text{total boilers})$$

The %VFD represents the stepped percentage of boilers running where:

$$0Vdc = 0\% \text{ (to) } 10Vdc = 100\%$$

If there are (6) boilers in a system and (2) are running, the control signal = 33% or 3.3Vdc. This signal could then be applied to a system pump's VFD to control the speed of the pump relative to how many boilers are firing. The VFD would need to be set appropriately to allow the correct flow through each boiler.

In low volume systems sudden temperature changes may occur when the flow is stepped up or down by a large percentage. In these situations the ADAPTIVE MOD may need to be disabled and the ORIGINAL KN method used. Other adjustments may also be required.

Currently, no failsafe mode is available in the event the Master boiler's control fails. If this method is employed, a failsafe boiler could be used to override the control signal and enable the system pump's VFD using some external wiring and an external relay, or have the VFD default to a safe speed on loss of the control signal.

If (2) pumps are available, pump rotation is available. The rotation of the (2) pumps can be controlled using two methods.

3. Pumps are switched based on the system run time
4. Pumps are switched by the difference between each pump's runtime. The HeatNet control keeps a running record of each pump's runtime in hours. If a pump is taken offline or replaced. The runtimes can then be adjusted until they become equal.

These features may be selected in the menu, SETUP:PUMP OPTIONS:SYSTEM PUMP:PUMP ROTATION

The **local circulator pump** is supported by (3) modes and (2) features.

1. The first mode allows the circulator pump to remain on, unless the control's outside high air temperature setting has been met when using Warm Weather Shutdown.
2. The second mode will allow the circulator pump to be turned on whenever there is a call for heat (any control input). This mode will stop the circulator pump when the call for heat is lost and the pump post purge time has been satisfied.
3. The third mode works much the same as mode 2, but it allows the inlet sensor (RETURN) to be used with the outlet sensor (SUPPLY) to keep the pump on until a delta (difference) temperature is met. A return temperature sensor is required for this mode, because the delta temperature (SUPPLY – RETURN) measured is across the boiler. In this mode, the post purge time is also used. After the delta temp has been met, the post purge time needs to expire before the pump is turned off. This mode works much the same as mode 2.

PUMP/VALVE OPTION: This is a special feature of the local circulator pump to prevent deadheading water flow when all boilers are off. When this feature is enabled, the master boiler will enable its local circulator pump/valve when **NO** boilers are running. If boilers are running in LOCAL override and not controlled by H-NET, but are visible to H-NET, the pump(s) on these boilers are presumed ON. In this situation, the master **will not** enable its circulator pump/valve unless it is running.

Another feature of the PUMP/VALVE OPTION is to control a local (primary) pump using a Variable Frequency Drive. This feature may be required when a secondary system pump is also variable speed. To enable this feature: **SETUP:PUMP OPTIONS:LOCAL PUMP PUMP/VALVE OPTION:LOCAL PUMP VFD: ON**. Setting this Option to ON will map the control signal on J4 pins 1+ and 5- to the modulation rate. (2) wires need to be run from J4.1+ and J4.5- to the VFD's input connection. Ensure that the JS1 shunt

jumper on the control board is in position 0-10 or 4-20mA as required.

Auxiliary Function Options

Relay K5 and the terminal J13 DAMPER is used to control a combustion air damper. J12B.7 & .8 are used to detect the dry contact proof switch from the damper. A proof time of up to 4 minutes can be set before the boiler can start or an alarm condition will occur. The Combustion Damper can be setup in the **SETUP:AUX FUNCTIONS** menu.

Using the LINKED/Common setting, the Master boiler controls a system damper, so in the event this damper fails to open, the system will not start. If the Master boiler's system damper fails, then no call for heat will be made to the member boiler(s).

Using the INDEPENDENT setting, each member boiler can control its own damper and is independent of the Master boiler when a call for heat is made to the member. This allows for separate dampers for each boiler. They can be wired to J12B terminals 7 and 8.

If a common system damper is used (controlled by the Master boiler), each individual boiler must prove that the combustion air damper is open when it is placed in LOCAL. This may be done using J12B terminal 7 on all boilers wired to the damper's prove switch. Terminal 7 is the sense input and terminal 8 is 24 VAC. Connecting a wire to terminal 8 is not recommended.

See Figure 37, *Common system damper wiring*, Page 57.

NOTICE A separate/independent 24 VAC source is recommended to be used for the damper prove switch when a common system damper is used. If you use terminal 8 to supply power from the Master and the Master is powered OFF, no boiler will be allowed to fire due to the loss of power through the prove switch. A backup boiler will also need to have the damper relay contacts wired in parallel with the Master for when the Master is powered OFF.

A second wire on the Master J12B terminal 7 is then connected. The other end of this wire is then run to the first Member boiler J12B terminal 7. If another member boiler is present, a second wire can be connected to the first member boiler J12B terminal 7 and the other end connected to the other boiler J12 terminal 7. This method can be continued if additional boilers are present. This input must be selected in the **SETUP:AUX FUNCTIONS:COMBUST AIR DAMPER** menu.

Outdoor Reset

The Outdoor reset feature allows the water setpoint temperature to change dynamically with the outside air temperature. It also provides an adjustable temperature that shuts the boiler (or boiler system) down when the outside temperature rises above it.

Figure 26 Outdoor reset curve, typical

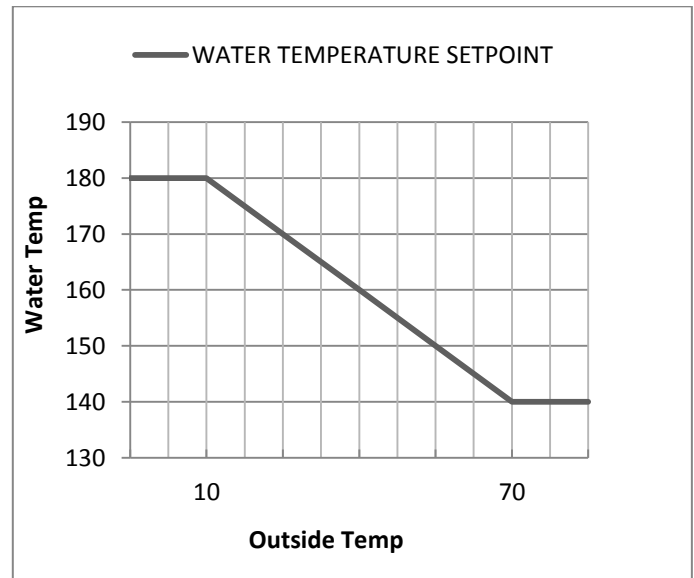

The above chart shows how the water temperature setpoint changes with the Outside air temperature. The four values of 180, 10 and 140, 70 are the default values:

WATER TEMP LOW OA TEMP	180 °F 10 °F	Water temp @ outside air temp
WATER TEMP HIGH OA TEMP	140 °F 70 °F	Water temp @ outside air temp
WWS Setpoint	72 °F	Outside air temperature where Warm Weather Shutdown occurs
WARM WEATHER SD=ON		If set to ON here

The chart depicts what the water temperature setpoint will equal with a corresponding outside air temperature. At an outside temperature of 10F and below, the water temperature setpoint will be limited to 180F. With an outdoor temperature of 70F and above, the water temperature will be limited to 140F. The water temperature setpoint will track along the charts plotted line with corresponding outside temperatures.

The OR OVR (Outdoor Reset Override) input on J12A can be used to override this Outside Air Setpoint and maintain the water setpoint at the LOCAL or SYSTEM SETPOINT value

when a contact is closed across this input. This can be used as a Domestic Hot Water demand input.

Another function of the OUTDOOR RESET is the Winter/Summer mode ((W)arm (W)eather (S)hutdown). With the WWS SETPOINT set to 72F and WARM WEATHER SD set to ON, the boiler/system will enter summer shutdown when the Outside Air temperature rises above 72F. While in this state, the OR OVR input on J12A can be used to bring the boiler/system on to maintain the water setpoint at the LOCAL or SYSTEM SETPOINT value.

During WWS operation, the System pump will not be enabled just the Local pump unless the SETUP:SYSTEM PUMP:OVR ENAB IN WWS is set to ON. This is the System Pump Priority mode. When SETUP:SYSTEM PUMP:OVR ENAB IN WWS is set to OFF, the system pump will not come on while in WWS with the OR OVR override input closed.

Sensors

The H-Net control supports a standard 10K thermistor (Type ACI/10K-CP). These sensors can be calibrated to the control by entering the sensor menu and placing a precision 10k resistor on an input.

NOTICE Immersion sensors must have wells.

There is also a provision to use a 1K platinum sensor for the stack temperature. The 10k thermistor is limited to a usable range of 270F, and the 1k platinum sensor to upwards of 1000F. The S5 DIP switch is used to configure one or the other.

Stack Temperature

The version 3 control also supports an optional 1k platinum stack sensor. If the Stack Sensor is present, a warning will occur at 325F and greater. During the Warning condition, for every degree F over the warning temperature of 325F, the boiler's input will be limited by 4% until the boiler is running at low fire. If the SETUP: AUX FUNCTIONS: HEAT EXCHANGER: ALARM TYPE: is set to "FAULT" the boiler will halt and the Alarm relay will close when the Stack temperature exceeds 350F. The boiler will then be allowed to restart when the Stack temperature drops below 325F.

The Stack sensor should be a 1k ohm platinum type sensor. Part # 0040-1300. To configure the 1k PT Stack sensor, Switch S5.3 should be set to the NONE position and S5.4 set to PLATINUM STACK. The sensor will then be auto-detected after a power cycle.

Security

A password can be used to lock out control and setup features. It can be enabled, but is shipped in the disabled state.

Saving Configuration Settings

Prior to upgrading firmware or when some changes need to be done to the settings the menu ADVANCED SETUP: LOAD DEFAULTS: CONFIG ? can be used to save the current settings. Once the settings have been saved they can be restored by using the ARROW keys to change between SAVE and Restore.



USB Features

The HeatNet V3 control supports a USB updating system and desktop connectivity using the HeatNet Control Pro software.

In order to ensure that a valid firmware file is always available on the HeatNet board, (2) file storage locations are available. A firmware file is loaded at the factory in both locations. This is to ensure that if a bad file is loaded by the user, the factory loaded file can be re-loaded to get the board functional again.

The firmware loading menu is located at; ADVANCED SETUP: SYSTEM: LOAD FIRMWARE. The following explains the menus.

Selecting **USB DRIVE** will read the FIRMWARE directory on a flash drive and display any .hex files located there. The USB flash drive needs to have a directory called "firmware" located in the root directory. The downloaded firmware .hex file needs to be placed there. Then the flash drive needs to be inserted into J6 on the HeatNet control board. Follow the on screen prompts and then select the file using the arrow keys. Once a file has been selected, a STORAGE LOCATION needs to be selected. There are (2) storage locations for the new file. Location 1 is used for normal updates and Location 0 is for the factory stored backup file. When the Storage location (default is Location 1) is selected the file will be loaded into a permanent storage memory location. Next, the control will reboot and copy this new program into running memory, reboot, load factory defaults, and then reboot again.

Selecting **USB CABLE** requires connecting a USB cable and running the Firmware Update program from a PC. This process takes much longer and requires a Personal Computer (laptop) to be taken to the boiler site. Again, follow the on screen prompts to down load the program into a storage location as done when using the above USB DRIVE loading menu. You will need the HeatNet Pro software which can be downloaded from the website.

Selecting **SAVE FILE** will display the currently stored files in the storage memory locations. Use the arrow keys to select a stored file for copying to running memory. When **SELECT** is pressed the file will be marked so it will be loaded on the next power cycle. Power cycle the boiler to begin copying the file from stored memory to running memory.

NOTE: to access the factory backup program, the P3 BOOT shunt on the HeatNet control board needs to be connected and the CAL/NORMAL switch placed in the CAL position. The BOOT jumper is located close to where the ribbon cable for the display plugs in. If the control is power cycled in this condition, the factory program will overwrite the existing running program. If in the LOAD FIRMWARE menus, STORAGE LOCATION 0 will be an allowed storage location.

Diagnostics

The H-Net control can display and identify faults in a meaningful way. If an interlock trips, it will be indicated in the main screen display, along with an audible alarm (mounted on control board) and a set of relay contacts will close. A record of this, with a time stamp, will also be entered into the log as an aide in the diagnosis of the event. The log can be downloaded and a histogram used to display the data. If using Modbus, BACnet, or LonWorks, there are software flag bits in registers available.

Open and shorted sensors are checked continuously, so that in the event of a sensor failure, the system shuts down and the alarm relay is closed.

If a pump fails (flow switch required), or the flow switch fails, the boiler will cycle the start condition every 10 minutes in an attempt get the boiler restarted.

If the damper fails to open and never closes its proof switch, a retry algorithm will attempt a retry. Every 10 minutes the damper relay will cycle and try to open the damper again.

If the H-Net control closes the last interlock string connected to the ignition control and the ignition control never closes its Blower Relay, the H-Net control will wait 2 minutes. The H-Net control will then retry for the duration of the local pump post purge time and then retry the ignition sequence. During this time “retry strt” will be displayed in the status screen.

After (5) attempts the H-Net control will lock out and display call service.

Blower Protection

With the use of the Ametek blower the HeatNet control has assumed many of the responsibilities that the Variable Frequency Drive provided. Some of these include the Acceleration, Deceleration, Braking, and Soft Start.

The most sensitive of these (4) functions is the Soft Start. The Soft Start overcomes the motor’s attempt to run at a high rate of speed before overcoming inertia. In the larger Ametek blowers a higher starting torque is required to break the inertia of the Ametek’s flywheel effect. If the Ametek motor cannot transform its electrical energy into mechanical energy fast enough, (due to this inertia) a high input current to the motor will result. The Ametek motor would then shut down and lock out due to this current. The only way to reset the Ametek blower due to the over current condition is to power cycle the boiler.

Also, due to the nature of the inverter circuit that is used to change the AC line input to a DC voltage to power the motor, a sizable bank of capacitors is used. When the blower is first powered up, these capacitors are empty and develop a large inrush of current.

In order to provide a means of controlling these situations and preventing downtime, the HeatNet control allows a relay to control the power fed to the blower. This is done by wiring the 120 VAC power to the J13A.1 Stage 4 relay contact using black 18 gauge MTR/TEW wire. Then wiring (same wire type) from J13A.2 to the Ametek blower contactor’s enable input. This allows the HeatNet control firmware to control power to the blower by switching the contactor ON or OFF. The reasons for this are as follows:

1. The Stage 4 relay has been allocated to help bring the power up in steps. These steps are used to minimize inrush currents by engaging the blower’s contactor (7) seconds after the main power has been applied.
2. In the event a blower lockout has been determined, a (10) minute retry cycle, (3) times will occur. At the time the blower has been detected as locked out, the retry cycle will start. The Stage 4 relay will be de-energized for (8) minutes. Then the Stage 4 relay will be energized for (2) minutes. This will effectively power cycle just the blower. The call for heat will then be allowed in an attempt to start the boiler. After (3) failed retry attempts, the boiler will lock out.

Communications

The H-Net control has the ability to communicate using the MODBUS protocol with a building management system. Most registers and functions are available for MODBUS access. Access is allowed using the RS485 MODBUS PORT connector on the communication board. Version 2.x Control has these connections integrated on the main board.

An optional BACnet or LonWorks bridge module can be used to connect the MODBUS network to a BACnet or LonWorks network. See Method 5 control.

Failsafe Modes

FAILSAFE MODES have been added to help protect systems from loss of heat conditions. When using one of these modes **ensure that you connect any DAMPER control, or system pump control to safely allow operation** with the assumption that the MASTER boiler or BMS system is DOWN.

FAILSAFE REQUIREMENTS:

1. Since the Member boiler that will be assigned the Failsafe duty will always turn the system pump ON, this boiler should not be used for DHW heating. If the Master controls the system pump, then the Failsafe Member boiler would need to control the system pump in parallel with the Master boiler. Wire the System Pump contacts in parallel with the Master.
2. If the combustion air damper is used as a common system damper, the Failsafe boiler should be wired to control the damper in parallel with the Master boiler.
3. The Failsafe boiler must have the LOCAL SETPOINT set to the same setpoint temperature as the Master boiler's SYSTEM SETPOINT.

Be aware that the boiler may start without a call-for-heat in the FAILSAFE MODES. FAILSAFE MODES can be accessed through the:

SETUP:AUX FUNCTIONS:FAILSAFE MODES.

The following are types of Failsafe conditions.

1. Building Management System Failure

If a BMS system is controlling the setpoint and enabling the boiler system, a timer is provided to allow operation of the system in the event that communications are lost with the BMS system. The HeatNet boiler system will

run locally if communications is lost and this timer expires due to the lack of being updated.

The system setpoint timer and system setpoint work in tandem to externally control (i.e. a BMS - building management system) the operating setpoint. The setpoint (countdown) timer should be loaded with a timeout value (in seconds) prior to writing the system setpoint. When the timer reaches zero, the control assumes that the BMS is no longer operating and the local setpoint (saved on the control) is reloaded. If the setpoint timer is not written, a default timeout value of 60 seconds is assumed. The timer is automatically reloaded with the default value when a setpoint is written.

NOTICE The BMS mode is always on and no menu item is available.

2. HeatNet Communications Lost

SETUP:AUX FUNCTIONS:FAILSAFE MODES:H-NET COMM LOST:

This mode allows a member boiler to run in LOCAL if the communications link via the H-NET cable is lost. This includes the MASTER boiler losing its Control board, Communications board, or the power on the MASTER is switched OFF. When this MODE is set to ON, and if the member boiler loses it's link (heartbeat packet over the H-NET cable) to the MASTER Boiler, this MEMBER will fire to the LOCAL setpoint.

NOTICE The heartbeat packet over the H-NET cable needs to be lost for 10 minutes.

This MEMBER boiler will continue to run at the LOCAL setpoint until H-NET communications from the MASTER boiler is re-established.

Ensure that this Member boiler's Damper and System pump control are configured correctly with the assumption that the Master is not powered. Also ensure that any other System settings related to outside air temperature sensing and system interlocks are set to provide safe operation.

Domestic Hot Water can also be provided using this mode. See the DHW section of this manual.

3. Low Temperature Protection

LOW TEMP: OFF, SUPPLY, HEADER, DHW, or RETURN

This mode may be used by the MASTER or MEMBER boiler and can be used as a type of freeze protection. In this mode you may select which Sensor you wish to monitor, or you may opt to turn this mode OFF. If you select a sensor, you may then associate it with a

temperature at which the boiler will turn ON. Once the temperature at this sensor falls below the LOW TEMP temperature the boiler will start and fire to its LOCAL setpoint. Once the Boiler reaches it's setpoint it will turn OFF.

4. Using the Base Load Relay

If there are no boilers available to fire (offline or faulted) and there are no boilers in local override, and there is a call for heat, The J4 Base Load relay will close. If a boiler becomes available and needs to fire, the Base Load boiler will remain firing until the temperature exceeds the band. This is provided to keep the system from entering a no heat situation.

Flow Options

Three methods to limit the boilers based on flow are provided.

3. Flow Limited Control (BMS)
4. Boilers Limited Control (BMS)
5. Flow Meter

The flow settings are used to limit HeatNet's ability to add boilers when the system flow changes. In variable flow systems, and when the system flow is reduced, any boiler(s) that is/are running may develop a high delta temperature across the boiler. When this occurs, the boiler(s) will enter a high delta T protection mode and drop to half of the rate called for. At this time, the Master may not be able to achieve setpoint due to the reduced output with the running boiler(s). The Master will then call on more boilers to achieve setpoint, but at the same time splitting the flow through the boiler(s) it has running. The flow can be so reduced that the boiler(s) trip their operating limits or even their high limits.

A flow meter input is supplied on the analog input 4-20 mA (2). This input can be configured to capture flow in the system that will be used to limit the # of boilers to fire. If a flow meter and a System Return sensor are present, a BTU load measurement will be displayed in the running screen. The BTU value is relative to the accuracy of the sensors, the gas BTUs, the flow sensor accuracy, and is only available as an estimate of the BTU load. A calibrated BTU meter would be required to get a more accurate measurement.

The BTU load value may also be accessed through Modbus read registers 30242 (upper 16 bit word) & 30243 (lower 16 bit word). These two words will need to be combined in order to get the BTU load value.

When using the BMS GPM register the BTU values are only calculated to a whole GPM since the BMS GPM register currently does not support floating point numbers.

The Building Management System (BMS) also has the ability to limit the # of HeatNet boilers allowed to fire. When a system has a fixed amount of boilers that HeatNet reports are available, the BMS can limit the # of boilers that can fire. The BMS can write the GPM value it has for flow, or directly write a register with how many boilers HeatNet can control. If the BMS GPM flow feature is active, the direct control becomes inactive.

Note: using these features can limit HeatNet's ability to maintain setpoint.

6. **Flow Limited Control:** This method helps HeatNet to limit the # of boilers firing based on the System Flow in GPM. In variable flow systems, this will limit HeatNet's ability to add new boilers when insufficient flow is available. The # of boilers allowed to fire is determined by:

$$\# \text{ of HeatNet boilers that can fire} = \frac{\text{BMS GPM Set Rate}}{\text{LOWEST FLOW}}$$

To activate this flow limited feature for use with a BMS:

- b. Set ADVANCED SETUP: FLOWMETER: FLOWMETER? YES
- c. Set ADVANCED SETUP: FLOWMETER: GLYCOL MIX ? % , Currently, any mix over 10% de-rates the flow by 30% (rule of thumb method). Example: if the LOWEST FLOW = 50 GPM, HeatNet will calculate a New Lowest Flow required to be 65 GPM. The LOWEST FLOW does not need to be changed, but is calculated to 65 GPM and that value is used by HeatNet.
- d. Set ADVANCED SETUP: FLOWMETER: INPUT TYPE to BMS.
- e. Set ADVANCED SETUP: FLOWMETER: SET PARAMETERS?
Enter LOWEST FLOW: (The automatic value loaded will equal the lowest flow required for this boiler (it is adjustable). It should be = to the lowest flow of the largest boiler in the system). The HIGHEST FLOW & FLOW FACTOR are currently not used with this release. Once flow meter manufacturers have been determined, new firmware will become available.
- f. Write to address BMS GPM register 40019 with a valid flow (0 -1500 GPM).
- g. **If a new GPM value is not written within 10 minutes, this feature will be deactivated until a new flow value is written. Ensure periodic updates of the flow register are done within 10 minute intervals.**
- h. To check if HeatNet is in a flow limited state, read the boiler status 4 register starting at address 30160 for the Master Boiler; if Status 4 bit (12) is set, it indicates that the HeatNet control is running with limited boilers due to insufficient flow derived from the GPM value.

- 2. **Boilers Limited Control:** This feature allows the BMS to directly change the amount of boilers that HeatNet can control.

To Activate the Boiler limited feature:

- a. Read Modbus address 30241 to see how many boilers HeatNet has available to fire. MODBUS AVAILABLE BOILERS register.
- b. Determine how many boilers the BMS system will require.
- c. Write to address BMS LIMIT BOILERS register 40020 with the # of boilers HeatNet is allowed to control (0 - 16).
- d. **If a new boiler # value is not written within 10 minutes, this feature will be deactivated until a new boiler # is written. Ensure periodic updates of the flow register are done within 10 minute intervals.**
- e. To check if HeatNet is in a BMS limited state, read the boiler status 4 register starting at address 30160 for the Master Boiler; if Status 4 bit (13) is set, it indicates that the HeatNet control is running with limited boilers due to the BMS system specifying BMS LIMIT BOILERS being less than the available boilers.

- 3. **Flow Meter:** Used to control the # of HeatNet boilers allowed to fire. HeatNet will look at the # of boilers it has available, and the amount of system flow to determine how many of boilers it can fire. **As an Example:** An Onicon F-1210 Flow Meter provides simultaneous 0-10V and 4-20mA outputs, so if the BMS system is using (1) output, the other may be used by HeatNet.

To activate this flow limited feature for use with an Onicon Flow Meter F-1210:

- a. Set ADVANCED SETUP: FLOWMETER: FLOWMETER? YES
- b. Set ADVANCED SETUP: FLOWMETER: GLYCOL MIX ? % , Currently, any mix over 10% de-rates the flow by 30% (rule of thumb method). Example: if the LOWEST FLOW = 50 GPM, HeatNet will calculate a New Lowest Flow required to be 65 GPM. The LOWEST FLOW does not need to be changed, but is calculated to 65 GPM and that value is used by HeatNet.
- c. Set ADVANCED SETUP: FLOWMETER: INPUT TYPE to mA 2 or VOLTS 2 depending on whether a 4-20 milliamp or 0-10 volt signal is used. The connection should be made from the Flow Meter to analog input 4-20 mA (2).
- d. Select ADVANCED SETUP: FLOWMETER: SET PARAMETERS?

Enter LOWEST FLOW: (The automatic value loaded will equal the lowest flow required for this boiler (it is adjustable). It should be equal to the lowest flow of the largest boiler in the system).

- e. Set the ADVANCED SETUP: FLOWMETER: FULL SCALE value to the full scale reading on the calibration card that came with the flow meter.
- f. The HIGHEST FLOW & FLOW FACTOR currently are not used with this release.
- g. These settings will use the equations:

4-20 mA: $\text{Measured GPM} = (\text{signal}/16) * \text{FULL SCALE flow}$

0-10 Volt: $\text{Measured GPM} = (\text{signal}/10) * \text{FULL SCALE flow}$

These settings may work with other flow meters (consult their respective manuals).

HeatNet Online

HeatNet Online is a web based system for fault notification, monitoring and tuning of a HeatNet based system. A HeatNet Online bridge module is required to connect a boiler (Usually the Master boiler) to the internet. The bridge is available for version 2.x and version 3.x HeatNet controls and is standard on V3.x. The bridge module provides an RJ45 connector for access to the internet. If an RJ45 hardline is not available, a wireless modem can also be used. Consult the factory or sales for available solutions. The HeatNet Online site may be accessed at: www.heatnet.net/ . A login Account/Password is required.

Once a user has registered a site, the users email can be set up to provide daily status messages and fault/alarm emails within minutes of trouble. This provides a valuable tool for technicians on the road. If the technician has a smart phone, they can be notified through the emails on their phone. They can then log on to the HeatNet Online website (from their phone) to determine the trouble. Sample email message:

HeatNet Online Alert

Church St – Address and building location displayed here					
Church Street Heat - Basement					
M (MB 750)	Fault	High Limit	May 17 2014 11:09AM	WVHID999999	View Alert Data

Once the user has logged in, a selection screen for the building sites the user has registered will be displayed. When a building site is selected, the main Live screen will be entered. This is the HOME screen and provides a quick view on the status of the site.



Selecting the History tab allows a runtime Histogram of the system. The histogram displays temperatures and states of the system in a date/time format. Also displayed is the Master boiler log, faults, messages, modulation, and events. To the right of the histogram is the Master Boiler's log. Since the HeatNet bridge only transmits at 1 minute intervals, the log can be used to precisely view the state of the boiler at the time of the event (in-between minutes).

This screen is an excellent way to diagnose system problems and tune systems for optimal performance.



Data Points can also be viewed in a manner other than a histogram as pictured below. The date/time picker can be used to mine the raw data stored on the HeatNet Online server.

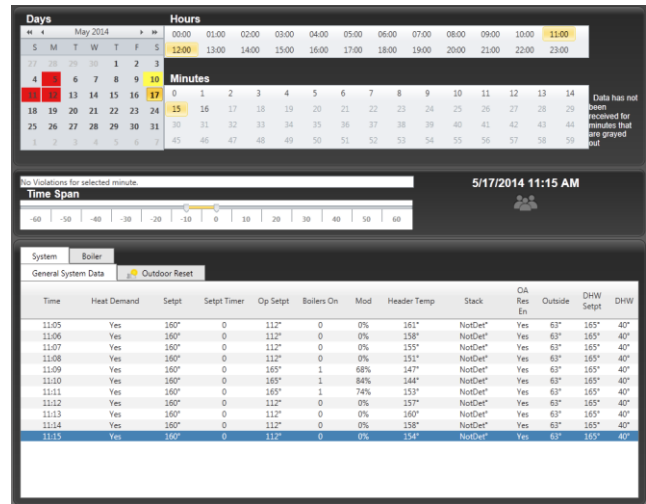

Runtime graphs of each boiler ensure even runtimes are being observed by a properly operating system.



This is just an overview of HeatNet Online and a few of the screens that are available.

Domestic Hot Water Methods

Domestic Hot Water control is supported using (6) methods. When using the Domestic Hot Water methods, the wire jumper, JPS1 on each control board providing Domestic Hot Water, must be cut to limit the boiler's maximum output temperature to 200F. Refer to Figure 42 for control input and output locations.

Figure 27 Jumper JPS1

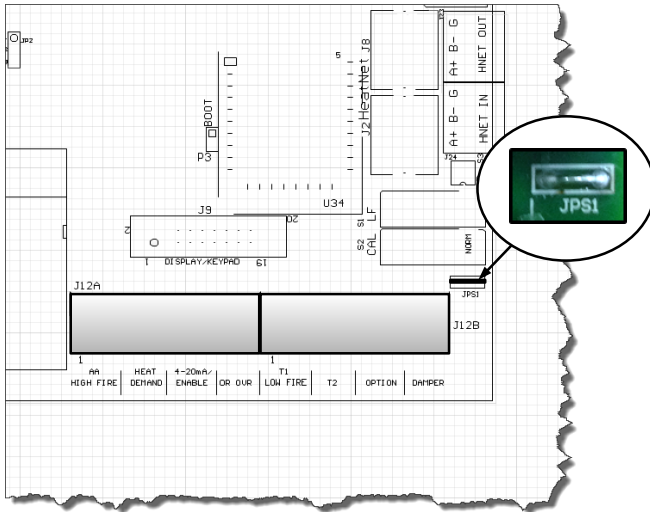

Note: Most of these methods use a separate PID control for the DHW. This means that the Master boiler can be used to individually control its own DHW tank and provide space heating functionality at the same time.

A **MASTER TYPE** is required when using DHW. Its setting is located under the **DISTRIBUTED CTRL** menu. *Any time its setting is changed, a power cycle is required.* The menu choices are:

- AUTO:** will handle normal heating only applications. It may also be used when individual boilers have tanks connected and are controlled with the **DHW BOILER?** set to **LOCAL**.
- DHW:** is for **DHW** applications without space heating.
- MIXED:** Will allow mixed Space and DHW heating control of boilers by the Master.

The OR OVR input now functions in many of the methods as a DHW Heat Demand input (except **DHW Heating Only** method), but still retains the original OR OVR functionality in **AUTO**, if the DHW menus are not used (**DHW BOILER? NO**). If the **DISABLE TO CHANGE** message appears,

remember to remove the any call for heat including the OR OVR input.

When the **MASTER TYPE** is set to **MIXED** the **MODULAR BOILER SET** menu will contain (2) separate menus for controlling the **ADD BOILER DELAY**, **SHED BOILER DELAY**, **MODULATE DELAY**, and the **MOD MAX** for the system. This allows the independent control of boilers by the Master for each of the (2) PIDs.

DHW METHOD 1: DHW Heating ONLY using a DHW MASTER and Member boiler(s) employing H-Net.

This method requires a 10k thermistor connected to the DHW Sensor input of a DHW MASTER, or a stand-alone boiler, and a DHW tank. This method does not use a **HEADER** sensor. The DHW temperature is maintained by the space heating PID for backwards compatibility. With this method the OR OVR input does not function as a DHW enable and is not used. The Heat Demand input is used to enable/disable DHW heating operations.

The system pump is enabled on the Master as long as the Heat Demand input is closed. The Master's DHW pump is engaged only when there is a call for DHW heating by the system. This allows for a DHW loop/ buffer and A DHW tank that can be heated using the DHW pump/valve off of this loop/buffer.

Boilers are started as long as the tank's water temperature is below the (DHW SETPOINT – LOWER DHW DIFF). The first boiler is started immediately. The next boiler(s) is started after the **ADD BOILER DELAY** time expires. Boilers are not added when the temperature is above the (DHW SETPOINT – LOWER DHW DIFF) and below the **UPPER DHW DIFF**. Once the **UPPER DHW DIFF** is exceeded, boilers will shut off based on the **SHED BOILER DELAY TIME**.

Setting up this method is done via the menus in: **SETUP: DOMESTIC HOT WATER.**

1. Connect a 10k thermistor from the DHW tank's sensor well to J10B terminals on the DHW MASTER, or stand-alone boiler. Wire a pump or valve from the DHW pump or the System pump (normally open) relay contact to control flow of the heating water into the tank's coil or system loop.

The System pump will always be enabled as long as the Heat Demand input is closed. The DHW pump will be enabled whenever there is a DHW call for heat.

A DHW call for heat is when the DHW temperature is below the (DHW SETPOINT – LOWER DHW DIFF) or when the DHW temperature is below the (DHW SETPOINT +

UPPER DHW DIFF) and boilers are firing. After a DHW call for heat ends:

- A. The pump will remain on during a post purge pump cycle until the post purge timer expires.
2. Next, enter the **DOMESTIC HOT WATER** menu on the Master boiler. When prompted for **DHW BOILER?**, enter **NO**. The Master treats this method as a DHW system much like a space heating system.

Member boilers may set the DHW BOILER? to LOCAL and go offline to perform secondary DHW heating, but the Master setting must be set to NO.

Setting the **DHW BOILER?**, to **MIXED** using this method will cause erratic operation and the DHW pump to not be enabled.
 3. Change the **DHW SETPOINT** to the desired target temperature of the water in the tank. Once the control determines there is a call for DHW, the DHW SETPOINT is loaded and the Master boiler will target the setpoint.
 4. Now, change the **DHW LOWER DIFF** to the desired temperature (DHW SETPOINT – LOWER DHW DIFF) below which boilers are to be added. This setting corresponds to the minimum water temperature required in the tank. DHW heating will be initiated when the DHW tank's water temperature is below the temperature (DHW SETPOINT – LOWER DHW DIFF).

How long the temperature of the tank stays below the temperature (DHW SETPOINT – LOWER DHW DIFF) is used to determine when boilers are started along with the ADD BOILER DELAY TIME.
 5. Next, change the **DHW UPPER DIFF** to the desired temperature (DHW SETPOINT + UPPER DHW DIFF) above which boilers are to be shed. This setting is the maximum tank temperature. Setting the SHED BOILER DELAY TIME correctly will limit the maximum tank temperature to the (DHW SETPOINT + UPPER DHW DIFF). Setting the SHED BOILER DELAY TIME = 0 will shut off all boilers immediately once the (DHW SETPOINT + UPPER DHW DIFF) is exceeded.
 6. Press the DOWN arrow key again to position the cursor beside the menu item **DHW PRIORITY?**. Setting this value to YES will turn OFF the system pump when the DHW mode is active. Setting this value to NO leaves the system pump on.
 7. Press the DOWN arrow again and the menu item **POST PURGE** should appear. This is the time

that the DHW pump relay remains energized after the DHW SETPOINT has been satisfied.

- A. The pump will remain on during a post purge pump cycle until the post purge timer expires.
 - B. Pump on the Master boiler functions as a global pump.
8. Scroll down to **USE SENSOR?** Press the **SELECT** key and select **YES**, then press the **SELECT** key again. This will allow the boiler to control the tank or DHW loop temperature using the DHW sensor. The upper and lower differential temperatures will also be loaded.
 9. Press the DOWN arrow again and the menu item: **SHARING?**, will be displayed.

If this item is set to **OFF**, only boilers that are not firing will be checked for runtimes and fired. Set the **SHARING?** to **OFF**.
 10. Press the DOWN arrow again and the menu item **LOCAL PUMP OFF:** will be displayed.

Set this value to **NO**. This will leave the local pump on during a DHW heating cycle (backwards compatibility). Setting this value to YES will always keep the local pump off.

The Master's DHW relay will remain on as long as there are boiler's firing and the DHW temperature is below the (DHW SETPOINT + UPPER DHW DIFF). Once all boilers are off and the DHW temp is equal to or above the (DHW SETPOINT + UPPER DHW DIFF), the DHW pump will begin its post-purge time. If during this post-purge time the DHW temp falls below the (DHW SETPOINT + UPPER DHW DIFF), the DHW pump will remain on.

Setting this value to **YES**, will shut the local pump off during a DHW heating cycle, but will keep the local pump on for the LOCAL DELAY: 10s time before shutting off. This LOCAL DELAY: time can be adjusted in the next menu item by pressing the down arrow again.
 11. Press the DOWN arrow again and the menu item **PURGE TO THE:** will be displayed.

Set this value to **TANK**. This will purge the heat from the boiler into the tank or system loop. This will be done using the DHW pump after the DHW heating cycle is complete. Set **PURGE TO THE: TANK**.

If the **PURGE TO THE:** is set to **SPACE**, once the DHW cycle has completed, the Master will shut the DHW pump off within a few seconds. The **SPACE** setting is to be used only for mixed space and DHW heating.

12. Set the **HYB SENSOR = OFF**. This sensor is selectable for Method 5A only.

Now in the,

ADVANCED SETUP:DISTRIBUTED CTRL: MASTER TYPE select **DHW**.

NOTE: JPS1 MUST be cut on all boilers providing DHW.

DHW METHOD 2: Combination DHW and Space Heating using a MASTER Boiler and Member boiler(s)

(Master Type: MIXED)

This Method works much the same as DHW METHOD 1, but also has the ability to provide space heating. The Master boiler will use two PID controls to simultaneously maintain the DHW and space heating setpoints. This method is determined by **ADVANCED SETUP: DISTRIBUTED CTRL: MASTER TYPE: MIXED**.

This method utilizes a 10k thermistor connected to the DHW Sensor input and HEADER sensor input of a MASTER boiler. Setting up the DHW portion of this method is done via the menus in: **SETUP: DOMESTIC HOT WATER**. For information on setting up the space heating portion of this method, Refer to **Heat Demand Control Method 1** located in the CONTROL METHODS section.

be enabled or disabled much in the same way as the Heat Demand input for space heating.

The DHW pump is individually controlled on each boiler that fires in DHW. The Master does not use its pump globally when any DHW boiler is called. The Master only engages its DHW pump if it was called to perform DHW heating.

When using this method, a DHW band is also available by scrolling through the status screens. Press the DOWN arrow key when SYSTEM SET is displayed. The space heating band will be displayed on the left and the DHW Heating band on the right. The bands will operate in a split screen view.

When using MASTER TYPE: **MIXED**, The Master may control DHW and Space Heating needs. If the Master goes down or loses communication with the Member, a Failsafe mode is available to provide temporary heat.

The DHW Failsafe mode is active when a Member boiler's **SETUP:AUX FUNTIONS:FAILSAFE MODES:H-NET COMM LOST:** is set to **ON**. When this is set to on, normal DHW heating using the OR OVR or DHW sensor is disabled, even though there may be a DHW call on one of these inputs.

When the Master Boiler's communication is lost, and after 10 minutes of not being restored, the DHW inputs become active. The boiler now enters a stand-alone mode. The Heat Demand on that boiler becomes active and not only runs to provide failsafe space heating, but DHW heat as well. The STATUS screen will display an '*' and H-NET LOST. If a thermostat is used, the boiler will run to Method 5A until the thermostat input removes the DHW call. If a DHW temperature sensor is used, the boiler will modulate to maintain tank temperature. The DHW Call always has priority over space heating. A dual 10k sensor is available that can be wired from one tank to two boilers.

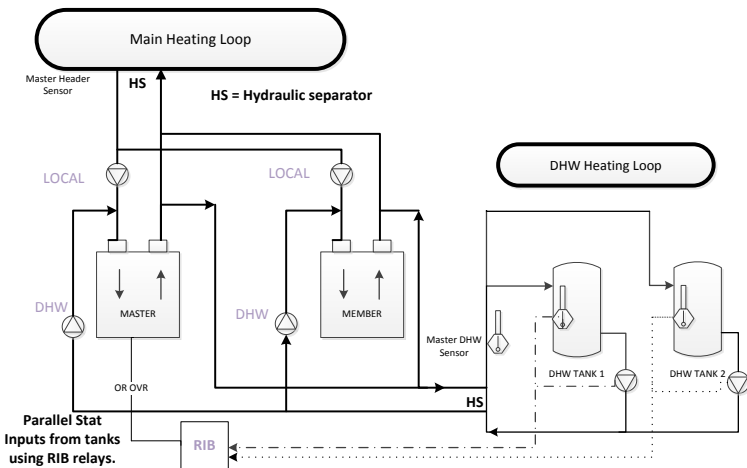

Example: Mixed DHW/Space Heating Simplified Drawing

When this method is used, the OR OVR input functions as an enable/disable. This allows the DHW heating function to

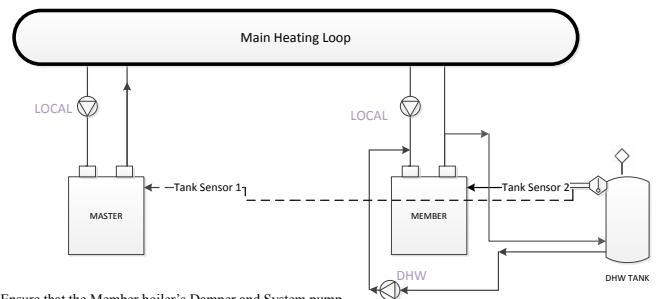

Ensure that the Member boiler's Damper and System pump control are configured correctly with the assumption that the Master is not powered. Also ensure that any other System settings related to outside air temperature sensing and system interlocks are set to provide safe operation.

Example: Failsafe Sensor Simplified Drawing

The above example uses (2) boilers. The Master controls the Space and Domestic needs. Failsafe control is provided by wiring the Member boiler to the tank sensor (dual sensor is optional) and any other system control needs the Member

may require in its backup role. Then one of the local DHW control methods can be used to implement DHW heating.

One advantage to this configuration is that a BMS can control the system through the Master. It can also monitor system status through a central location (Master boiler) by a BMS, or HeatNet Online. This failsafe method can also be used in the **Mixed DHW/Space Heating Simplified Drawing**.

Set up the Master boiler first:

1. Connect a 10k thermistor from the DHW tank's sensor well to J10B terminals on the MASTER, and connect a Header Sensor to the SYSTEM HEADER input. Wire any pump or valve from the DHW Pump relay's (normally open) contact to control flow of the heating water into the tank's coil or DHW loop.
2. Now, set the **ADVANCED SETUP: DISTRIBUTED CTRL: MASTER TYPE:** to **MIXED**. This setting informs the HeatNet control that (2) PIDS are to be used to control DHW and space heating.
3. There are two **MODULAR BOILER SETTINGS**, one for space heating and one for DHW heating. These (2) menus appear when the **ADVANCED SETUP: DISTRIBUTED CTRL: MASTER TYPE** is set to **MIXED**. The (2) Modular boiler settings are located in the **ADVANCED SETUP: MODULAR BOILER SET:** menu. Normally, there is only one, but with (2) independent PIDs, the (2) heating setpoints may behave differently due to their loads or for other various reasons. These allow for separate **ADD, SHED, MODULATE DELAY TIME,** and **MOD MAX** settings for DHW and space heating.
4. Next, enter the **DOMESTIC HOT WATER** menu. When prompted for **DHW BOILER?**, enter **NO**. We will enter **YES** when we are finished entering all parameters
5. Change the **DHW SETPOINT** to the desired target temperature of the water in the tank/ or DHW loop. Once the control determines there is a call for DHW heat, the DHW PID will target this SETPOINT.
6. Now, change the **DHW LOWER DIFF** to the desired temperature (DHW SETPOINT – LOWER DHW DIFF) below which boilers are to be added. This setting corresponds to the minimum water temperature required in the tank. DHW heating will be initiated by starting boilers when the DHW tank's water temperature is below the temperature (DHW SETPOINT – LOWER DHW DIFF).
7. Next, change the **DHW UPPER DIFF** to the desired temperature (DHW SETPOINT + UPPER DHW DIFF) above which boilers are to be shed. This setting is the maximum tank temperature. Setting the **SHED BOILER DELAY TIME** correctly will limit the maximum tank temperature to the (DHW SETPOINT + UPPER DHW DIFF). Setting the **SHED BOILER DELAY TIME = 0** will shut off all boilers immediately once the (DHW SETPOINT + UPPER DHW DIFF) is exceeded.
8. Press the DOWN arrow key again to position the cursor beside the menu item **DHW PRIORITY?**. Setting this value to **YES** will turn OFF the system pump when the DHW mode is active. Setting this value to **NO** leaves the system pump on. This time includes the DHW post purge of the DHW pump/valve.
9. Press the DOWN arrow again and the menu item **POST PURGE** should appear. This is the time that the DHW pump relay remains energized after the DHW SETPOINT has been satisfied. Once the tank has exceeded the DHW SETPOINT + UPPER DHW DIFF temperature and this DHW boiler has shut off (DHW SHED BOILER DELAY TIME), the post purge time will begin.
10. Scroll down to **USE SENSOR?** Press the **SELECT** key and select **YES**, then press the **SELECT** key again. This will allow the boiler to control the tank or DHW loop temperature using the DHW sensor. The upper and lower differential temperatures will also be loaded when set to YES.
11. Press the DOWN arrow, the menu item: **SHARING:** will be displayed. Sharing determines what happens when a DHW boiler is needed and none are available (all running is space heating and DHW heating). It needs to steal a space heating boiler that is running.

OFF Is first come first serve. If a Boiler is not available because all boilers are firing, the DHW firing algorithm waits until one becomes available, even though at least one is running as a space heating boiler. If a space heating boiler is needed, a DHW running boiler cannot be stolen for space heating. **Space heating has priority when DHW is trying to steal.**

CYCLE The DHW algorithm can steal a space heating boiler and fire it as a DHW boiler. The space heating boiler **stops** and then restarts as a DHW boiler. **DHW priority.**

NO CYCLE The DHW algorithm can steal a boiler that is already running as a space heating boiler. Instead of shutting down the space heating boiler, it does a hot swap, engaging the DHW pump and leaving the local pump running or shutting it off. Use this in conjunction with the **LOCAL PUMP OFF:** and the **LOCAL DELAY:** settings. **DHW priority.**
12. Press the DOWN arrow, the menu item: **LOCAL PUMP OFF:** is displayed. When a DHW heating cycle

begins, what to do with the local pump/valve is determined:

NO The local pump/valve will remain running during DHW heating.

YES The local pump will shut off with a delay determined by **LOCAL DELAY: seconds**. This allows the DHW pump/valve to prove before shutting off the local pump.

Piping of the system will determine which setting to use.

13. Press the DOWN arrow, the menu item: **PURGE TO THE:** is displayed. After a DHW cycle completes, the pump/valve can be selected to either purge to the **TANK**, or to the **SPACE** for the duration of the post purge time. This selection can use the space to dump the heat from the boiler and not overheat the DHW tank/load.
14. Set the **HYB SENSOR = OFF**. This sensor is selectable for Method 5A only.
15. Finally, Press the UP arrow until the menu: **DHW BOILER?** is displayed.. If JPS1 has not been cut, a message will appear instructing to do so. Once this is done, the MASTER boiler will control the temperature in the tank using as many boilers as it has available on H-Net along with the space heating needs. The boilers must be piped appropriately for this method to function correctly.

Now set up the Member boiler(s).

DHW BOILER? Set to **MIXED** on MEMBER boilers, only the MASTER boiler.

DHW SETPOINT This does not need to be set on MEMBER boilers, only the MASTER boiler.

LOWER DHW DIFF This does not need to be on MEMBER boilers, only the MASTER boiler.

UPPER DHW DIFF This does not need to be set on MEMBER boilers, only the MASTER boiler.

DHW PRIORITY This does not need to be set on MEMBER boilers, only the MASTER boiler.

POST PURGE This needs to be set on all boilers. All boilers control their respective DHW pump/valve when they are called to perform DHW heating.

SHARING This can be set on any boiler and will how boilers will cycle on/off when they are called to perform DHW Heating.

LOCAL PUMP OFF This can be set on any boiler to determine how the local pump/valve behaves when called to perform DHW heating.

PURGE TO THE: This does not need to be set on MEMBER boilers, only the MASTER boiler.

HYB SENSOR: = OFF. This sensor is selectable for Method 5A only.

NOTE: JPS1 MUST be cut on all boilers providing DHW. Cutting JPS1 limits to maximum temperatures to 200F.

DHW METHOD 3: DHW Heating using a Header Sensor Input

This method will control a tank temperature when the tank temperature setpoint needs to be maintained for extended periods with minimal cycling. Multiple boilers can be used via the H-Net, as this method employs the same PID algorithm as for space heating. **ADVANCED SETUP: DISTRIBUTED CTRL: MASTER TYPE: AUTO.**

1. JPS1 must be cut on all boilers providing DHW to ensure the maximum output temperature of all boilers is limited to 200F for DHW operation.

This Method is very similar to the DHW only method, but:

- A. The display will not indicate that it is a DHW heating boiler.
- B. The DHW Heating band will also not be displayed.
- C. The heating band will use the space heating band and not the UPPER and LOWER DHW heating band limits.
- D. DHW settings are not used.
- E. Set the **ADVANCED SETUP: DISTRIBUTED CTRL: MASTER TYPE:** to **AUTO**.
- F. This method is for backwards compatibility.

2. Use the **Heat Demand Control Method 1** located in the CONTROL METHODS section on page 22. Instead of placing the Header sensor in the Header pipe, place it in a well, in the tank, or a DHW loop.

The temperature at which boilers are staged **ON**, and then **OFF** is controlled by the **SETUP:BOILERS:HEAT BAND** differential. This can be understood by referring to the INTRODUCTION section on the MASTER in the beginning of this manual.

This differential has the added effect of heating the tank above the tank's setpoint temperature. If

the tank setpoint is set to 140F and the heat band is set to 10F, then the tank temperature will rise to 145F before the first boiler turns off (setpoint =140F +/- heat band/2). With (2) boilers running, the **SHED BOILER DELAY** time could add to the tank temperature. So, to ensure that all boilers are shut off at the upper point of the heat band, set the **SHED BOILER DELAY time to 0 or other small value**. This will effectively turn off all boilers at the upper heat band point of: (example) 145F.

Now, there is one more thing to consider, the pump's post purge time. Dumping the heat from all boilers (that were running) using a pump post purge cycle will have an effect on the tank's water temperature. Consider this when establishing the local pump's **POST PURGE TIME**.

3. Connect the Local Pump relay contact on J13 to enable the DHW pump. Set its post purge time to dump the boiler's heat into the tank when the boiler shuts off. **Be aware that this may heat the tank above the setpoint's upper heat band temperature.**
4. Enable the system by placing the LOCAL/REMOTE switch on the Master to the LOCAL position.

DHW METHOD 4: Space Heating with DHW Override of Setpoint on Master

This method is for controlling DHW utilizing a tank thermostat connected to a Master boiler. This method requires a thermostat input to the OR OVR. When the thermostat contact closes across the input **OR OVR (J12A .7 & .8)**, the control will sense this closure and override the space heating setpoint with the DHW setpoint.

**ADVANCED SETUP: DISTRIBUTED CTRL:
MASTER TYPE: AUTO.**

This method is for backwards compatibility.

In this mode, the boiler will fire to the **DHW** setpoint. The settings for space heating will be used except for the addition of controlling the DHW pump/valve.

13. Wire the dry contact from the thermostat on the tank to the input on J12A terminal 7 & 8. Also, at this time wire any pump or valve from the DHW Pump relay (normally open) contact (J13 terminals 9, 10) to control flow of the heating water into the tank's coil.

14. Enter the **DOMESTIC HOT WATER MENU**. When prompted for **DHW BOILER?**, enter **NO**.
15. **DHW SETPOINT** The setpoint should reflect the temperature desired in the heating loop when a tank is calling for DHW heat.
16. **LOWER DHW DIFF** This is not used.
17. **UPPER DHW DIFF** This is not used.
18. **DHW PRIORITY** Setting this value to **YES** will turn OFF the system pump when the DHW setpoint override mode is active. Setting this value to **NO** leaves the system pump on. This active period includes the post purge of the DHW pump/valve.
19. Select the menu item **POST PURGE**. This is the time that the DHW pump relay remains energized after the DHW thermostat has been satisfied. Once the tank has opened it's thermostat, the system/local setpoint will be reloaded and the post purge time will begin.
20. Select the menu item: **LOCAL PUMP OFF:** When a DHW heating cycle begins, what to do with the local pump/valve is determined:
 - NO** The local pump/valve will remain running during DHW heating.
 - YES** The local pump will shut off with a delay determined by **LOCAL DELAY: seconds**. This allows the DHW pump/valve to prove before shutting off the local pump.

Piping of the system will determine which setting to use.
21. Select the menu item: **PURGE TO THE**. After a DHW cycle completes, the pump/valve can be selected to either purge to the **TANK**, or to the **SPACE** for the duration of the post purge time. This selection can use the space to dump the heat from the boiler and not overheat the DHW tank/load.
22. Set the **HYB SENSOR = OFF**. This sensor is selectable for Method 5A only.
 - Follow the same steps as used to program DHW Heating using a Header Sensor INPUT. **USE SENSOR?**, select **NO**.

DHW METHOD 5: DHW of a Local Boiler's Tank.

Method 5A using a 10k Type II tank sensor.

This method is used to provide combination space heating and DHW heating. The boiler may be stand alone or in a HeatNet configuration. It is meant to fire an individual boiler in a DHW heating priority mode when that boiler's local tank temperature has a call for DHW heat (tank

sensor's temperature drops below the DHW Setpoint + Lower Diff). The boiler will stop space heating (if running) and switch to DHW heating. The DHW pump/valve will be engaged and the water temperature in the tank will be maintained by the boiler at the DHW setpoint. Once the tank temperature exceeds the Setpoint + Upper Diff temperature, DHW heating will stop and the pump/valve's post purge will start.

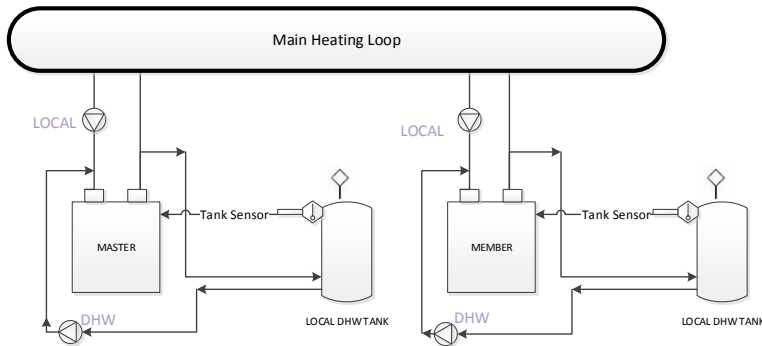

LOCAL DHW Simplified Drawing

When a tank's temperature sensor is connected directly to a boiler and the **DHW BOILER?** is set to **LOCAL**. The boiler will go offline from HeatNet and service the DHW needs of its local tank. If the boiler is running in space heating mode, then the "SHARING?" setting may be used to determine how, or if, to shut down before starting a DHW cycle. When the DHW cycle is complete (includes the post purge time of the DHW pump), the boiler will go back online with HeatNet and become available to fire.

During a DHW cycle the DHW setpoint will be loaded along with the UPPER and LOWER DHW DIFF. Also, the **ADVANCED SETUP: DISTRIBUTED CTRL: MASTER TYPE:** is set to **AUTO**.

When a 10k Type II sensor is used with this method, the OR OVR input functions as an enable/disable. This allows the DHW heating function to be enabled or disabled much in the same way as the Heat Demand input for space heating.

When using this method, a DHW band is also available by scrolling through the status screens. Press the DOWN arrow key when SYSTEM SET is displayed. The space heating band will be displayed on the left and the DHW Heating band on the right. The bands will operate in a split screen view.

23. Connect a 10k thermistor from the DHW tank's sensor well to J10B terminals on any boiler. Wire a pump or valve from the DHW pump or the System pump (normally open) relay contact to control flow of the heating water into the tank's coil or system loop.

The System pump will always be enabled as long as the Heat Demand input is closed and the **SETUP:**

DOMESTIC HOT WATER:DHW PRIORITY is set to **NO**. The DHW pump will be enabled whenever there is a DHW call for heat.

A DHW call for heat is when the DHW temperature is below the (DHW SETPOINT – LOWER DHW DIFF) or when the DHW temperature is below the (DHW SETPOINT + UPPER DHW DIFF) and boilers are firing. After a DHW call for heat ends:

- A. The pump will remain on during a post purge pump cycle until the post purge timer expires.
24. Next, enter the **DOMESTIC HOT WATER** menu on the Master boiler. When prompted for **DHW BOILER?**, enter **LOCAL**.
 25. Change the **DHW SETPOINT** to the desired target temperature of the water in the tank. Once the control determines there is a call for DHW, the DHW SETPOINT is loaded and the boiler will target the setpoint.
 26. Now, change the **DHW LOWER DIFF** to the desired temperature (DHW SETPOINT – LOWER DHW DIFF) below which boilers are to be added. This setting corresponds to the minimum water temperature required in the tank. DHW heating will be initiated when the DHW tank's water temperature is below the temperature (DHW SETPOINT – LOWER DHW DIFF).
- How long the temperature of the tank stays below the temperature (DHW SETPOINT – LOWER DHW DIFF) is used to determine when boilers are started along with the ADD BOILER DELAY TIME.
27. Next, change the **DHW UPPER DIFF** to the desired temperature (DHW SETPOINT + UPPER DHW DIFF) above which boilers are to be shed. This setting is the maximum tank temperature. Setting the SHED BOILER DELAY TIME correctly will limit the maximum tank temperature to the (DHW SETPOINT + UPPER DHW DIFF). Setting the SHED BOILER DELAY TIME = 0 will shut off all boilers immediately once the (DHW SETPOINT + UPPER DHW DIFF) is exceeded.
 28. Press the DOWN arrow key again to position the cursor beside the menu item **DHW PRIORITY?**. Setting this value to YES will turn OFF the system pump when the DHW mode is active (when the DHW pump is on). Setting this value to NO leaves the system pump on.
 29. Press the DOWN arrow again and the menu item **POST PURGE** should appear. This is the time that the DHW pump relay remains energized after the DHW SETPOINT has been satisfied.
 - A. The pump will remain on during a post purge pump cycle until the post purge timer expires.

30. Scroll down to **USE SENSOR?** Press the **SELECT** key and select **YES**, then press the **SELECT** key again. This will allow the boiler to control the local tank or DHW loop temperature using the DHW sensor. The upper and lower differential temperatures will also be loaded.
31. Press the **DOWN** arrow again and the menu item: **SHARING?**, will be displayed.

Set this item is to **OFF** or **CYLE** if the boiler is currently running in space heating and needs to be shut down before starting up in DHW.

If **SHARING?** is set to **NO CYCLE** a hot swap will occur. A hot swap is when the boiler is running in space heating mode and does not need to be shut down. The DHW pump will be energized without the boiler stopping. Once the DHW cycle has completed, the boiler will stop and wait to be called again for either space heating or DHW heating. A shutdown always occurs after a DHW cycle completes.

32. Press the **DOWN** arrow again and the menu item **LOCAL PUMP OFF:** will be displayed.

Set this value to **NO**. This will leave the local pump on during a DHW heating cycle (backwards compatibility). Setting this value to **YES** will always keep the local pump off.

Setting this value to **YES**, will shut the local pump off during a DHW heating cycle, but will keep the local pump on for the **LOCAL DELAY:** 10s time before shutting off. This **LOCAL DELAY:** time can be adjusted in the next menu item by pressing the down arrow again.

33. Press the **DOWN** arrow again and the menu item **PURGE TO THE:** will be displayed.

Set this value to **TANK**. This will purge the heat from the boiler into the tank or system loop. This will be done using the DHW pump after the DHW heating cycle is complete. Set **PURGE TO THE: TANK**.

If the **PURGE TO THE:** is set to **SPACE**, once the DHW cycle has completed, the Master will shut the DHW pump off within a few seconds. The **SPACE** setting is to be used only for mixed space and DHW heating.

HYB SENSOR = OFF

ADVANCED SETUP:DISTRIBUTED CTRL:
MASTER TYPE select **DHW**.

NOTE: JPS1 MUST be cut on all boilers providing DHW.

Method 5B using a Thermostat & Sensor.

Method 5(B) can also be used in a hybrid mode on **Member** boilers with a thermostat connected to the **OR OVR** input. This will enable DHW heating, and be used instead of having the 10k sensor's temperature detect when DHW heating is needed, but will use a selectable sensor instead to maintain setpoint.

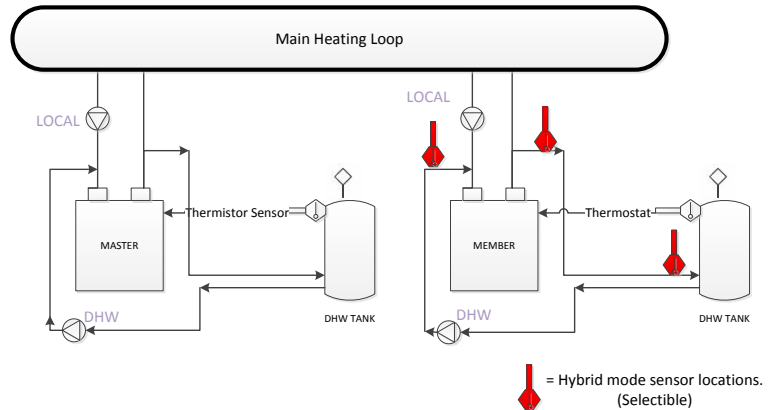

Simplified Drawing

When the **OR OVR** input sees the thermostat close, the DHW pump/valve will be engaged and remain energized as long as the **OR OVR** input sees that the thermostat is closed. The DHW setpoint along with the DHW heating band will then be loaded. A steady temperature will now be maintained using the **HYB SENSOR** setting in the DHW menu. This sensor will control the water temperature at the sensor's location, enabling or disabling the boiler as needed until the **OR OVR** input sees the thermostat open. Once the thermostat opens, the DHW pump post purge will begin.

The difference between setting up the **5A** method vs **5B** method is the "USE SENSOR?" setting. **5A** requires that the "USE SENSOR?" setting be set to **YES**, and the **5B** "USE SENSOR?" setting be set to **NO**. The **HYB SENSOR** setting must also be set in the **5B** mode to the sensor where temperature needs to be maintained. It must be set to **OFF** in the **5A** mode.

Method 5A

USE SENSOR? = YES
HYB SENSOR: OFF

Method 5B

USE SENSOR? = NO
HYB SENSOR: SUPPLY, DHW, RETURN

Each sensor selection/location has its advantages. Selecting the:

Supply sensor will limit the temperature/firing rate of the boiler, but may not be sufficient for continuous demand or speed in heating the tank. It is already available, so no additional sensor is needed.

Return sensor will allow the boiler to run its supply temperature up quickly, but may bounce off of the operating limit band. This would heat the tank in the shortest time, but may overheat the tank. It is already available, so no additional sensor is needed.

DHW sensor will allow the placement anywhere needed to maintain that locations temperature. This is an additional sensor that needs to be acquired.

A thermostat can be placed in a tank and connected to the OR OVR input. (**On Member boilers only**, The Master uses OR OVR already with DHW METHOD 4), When the thermostat contact closes across the input **OR OVR (J12A .7 & .8)** on a Member boiler, the control will sense this closure and disconnect itself from HeatNet.

DHW METHOD 6: DHW using Direct Control

If the control's 4-20mA input is set to HIGH PRIORITY the 4-20mA signal, once brought above the 4-20mA starting current can be used to override any other Heat Demand and direct modulate the boiler.

This can be set in menu: **ADVANCED SETUP:4-20mA INPUT**. It allows a member boiler to be taken offline and directly modulated by an external control.

If the Master is using it for heating and the 4-20mA is set to HIGH PRIORITY, an external control can now output a 4-20mA signal which will take over the boiler's fire rate and override all other heating demand inputs. The external control would also need to open any valves/ or pumps This is typically used for DHW control.

Wiring Connections

Figure 28 Dip Switches and Wiring

Wire Strip Length.



If the terminal blocks are of the **screwless** type, the wire should be stripped to **.42” or 10.67mm**.

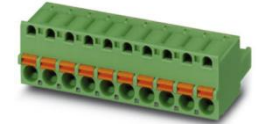

If the terminal blocks are of the **screw** type, the wire should be stripped to **.25” or 6.34mm**.

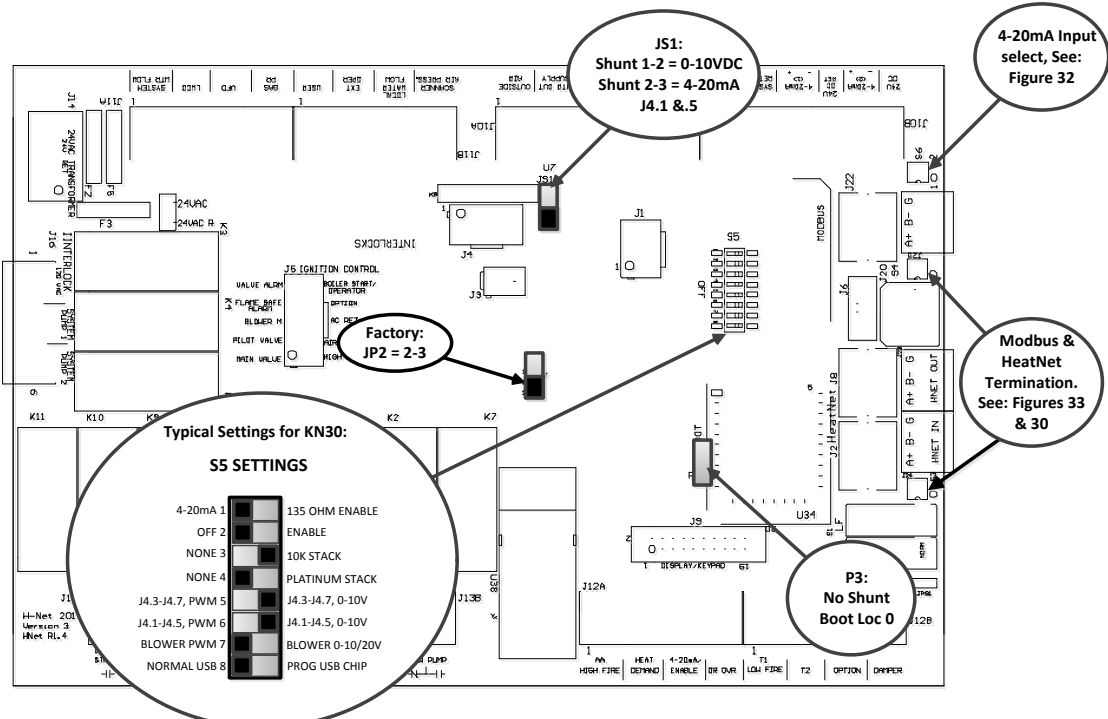

S5 Dip switches 1,5,7,8 set the Outputs of the J4 Connector.

- S5.1) Set to position 4-20mA for J4.1+ and J4.5- 4-20mA current mode (**JS1 = 4-20mA**). Set to position 135 Ohm for J4.1(W), J4.7(B), and J4.5® 135 Ohm mode (**JS1 = 4-20mA**). **NOTE: S5.6 must be set to J4.1-J4.5, 0-10V for the above to work in 4-20mA mode If JS1 is set to 0-10VDC then this switch has no effect on J4.1 and J4.5.**
- S5.2) NOT USED (Factory)
- S5.3) Set to NONE if there is no Stack Sensor or if a 1k Platinum stack sensor is used. Set to 10k STACK, if a 10k Thermistor stack sensor is connected to J10B.
- S5.4) Set to NONE if there is no Stack Sensor or if a 10k Thermistor stack sensor is used. Set to PLATINUM STACK, if a 1k Platinum stack sensor is connected to J10B.
- S5.5) Set to J4.3-J4.7, PWM, Configures J4.3+ and J4.8- for PWM output
- S5.6) Set to J4.3-J4.7, 0-10V, Configures J4.3+ and J4.8- for 0-10 VDC output
- S5.7) Set to J4.1-J4.5, PWM, Configures J4.1+ and J4.5- for PWM output (JS1 = 0-10VDC). Set to J4.1-J4.5, 0-10V, Configures J4.1+ and J4.5- for 0-10 VDC or 4-20mA output (JS1 = 4-20mA or 0-10VDC). This switch in conjunction with S5.1
- S5.8) Set to BLOWER PWM for Ametek Blowers. Set to BLOWER 0-10/20V for VFD controlled blowers.
- S5.8) Set to NORMAL USB = Normal operation Set to PROG USB CHIP (**FACTORY ONLY**)

Figure 29 Heating Method 1 H-Net, Master/member

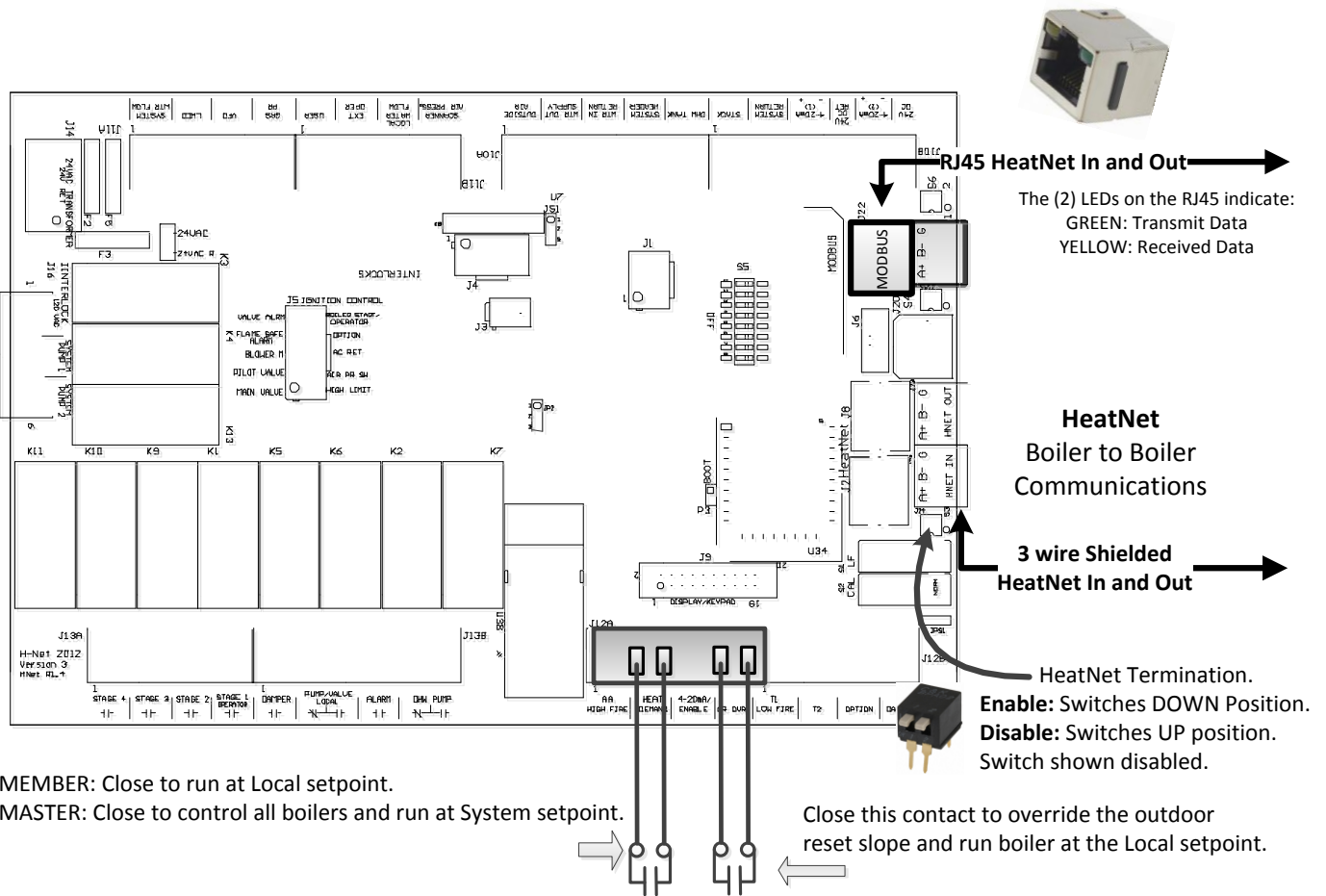
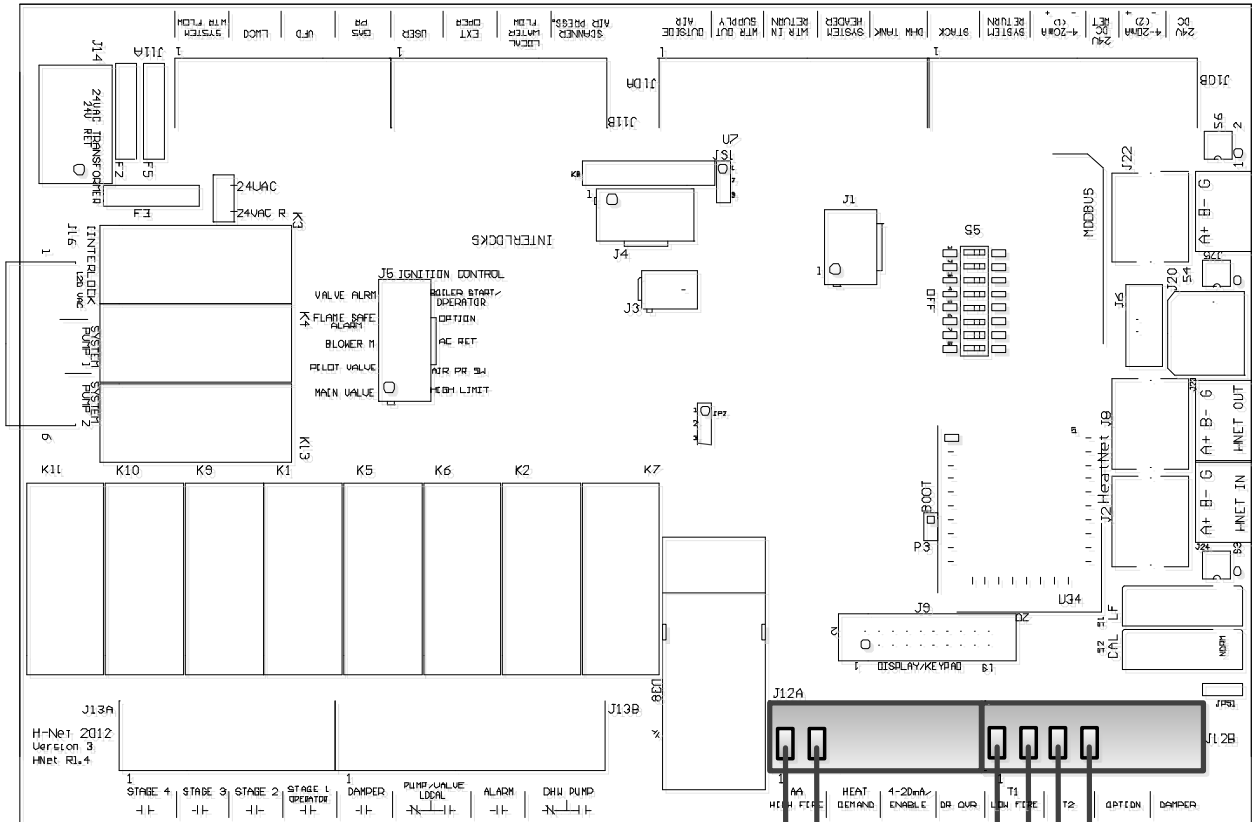

Figure 30 Heating Methods 2 and 4: AA-High Fire and High/Low, master or member boiler



Heating Mode 4: High Fire
Close this contact to run boiler at Highfire.



T1 T2

Heating Mode 2: Stage Control Inputs.

T1 or T2 Closed: Lowfire
T1 & T2 closed: Highfire



Figure 31 Heating Method 3 4–20 mA/ 0-10 VDC

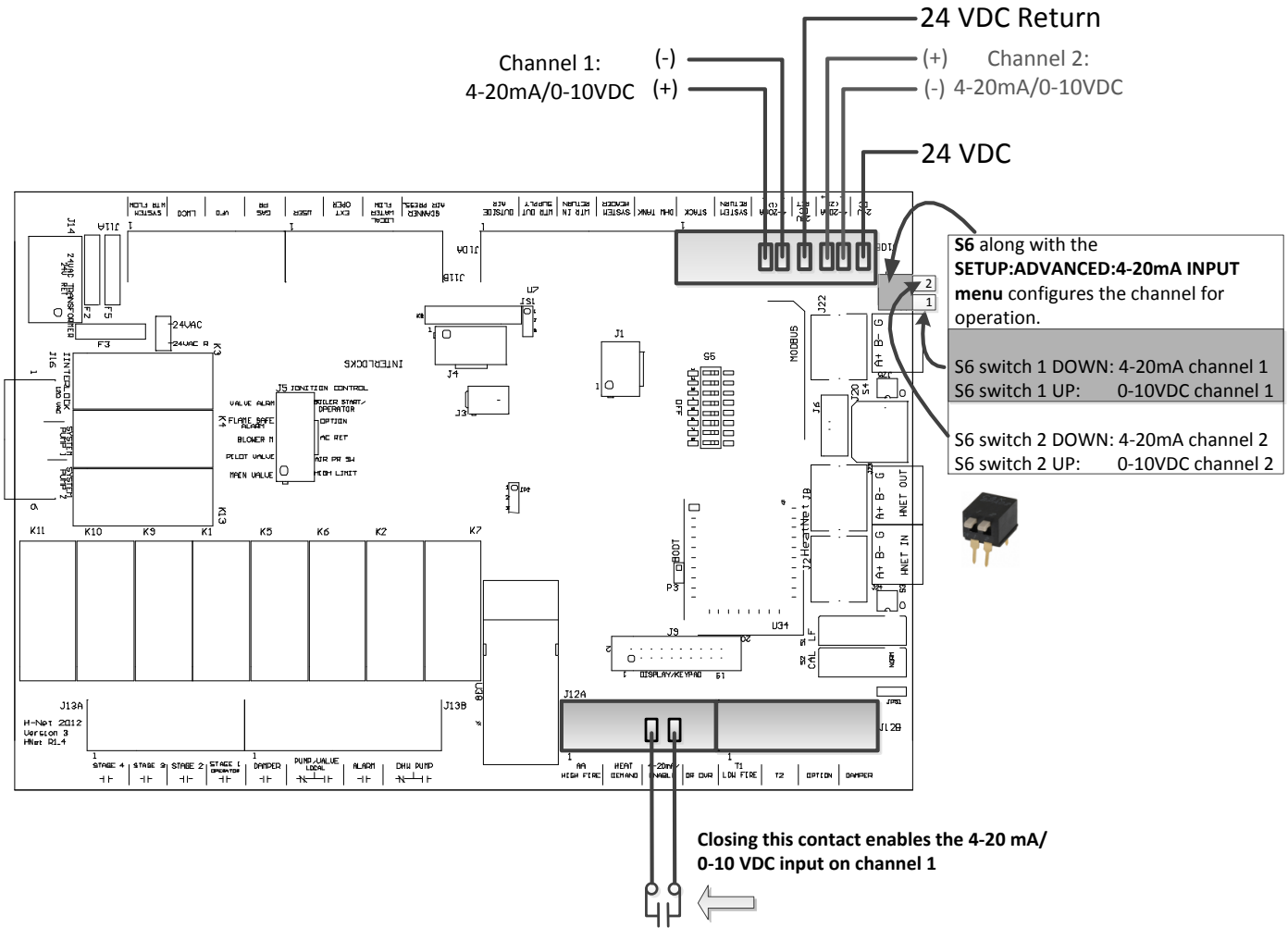

This Method allows direct modulation of the boiler based on a 4-20 mA control signal. A control capable of transmitting a 4-20mA/0-10 VDC control signal for the purpose of modulating a boiler and to control a common system temperature must be used with this method.

NOTE: If using a 0-10 VDC signal multiply any references to current in the manual by .5. Example: $5\text{ma} * .5 = 2.5\text{ VDC}$

Figure 32 Heating Method 5: MODBUS (Optional BACnet or LonWorks bridge — Processor)

The (2) LEDs on the RJ45 indicate:
 GREEN: Transmit Data
 YELLOW: Received Data

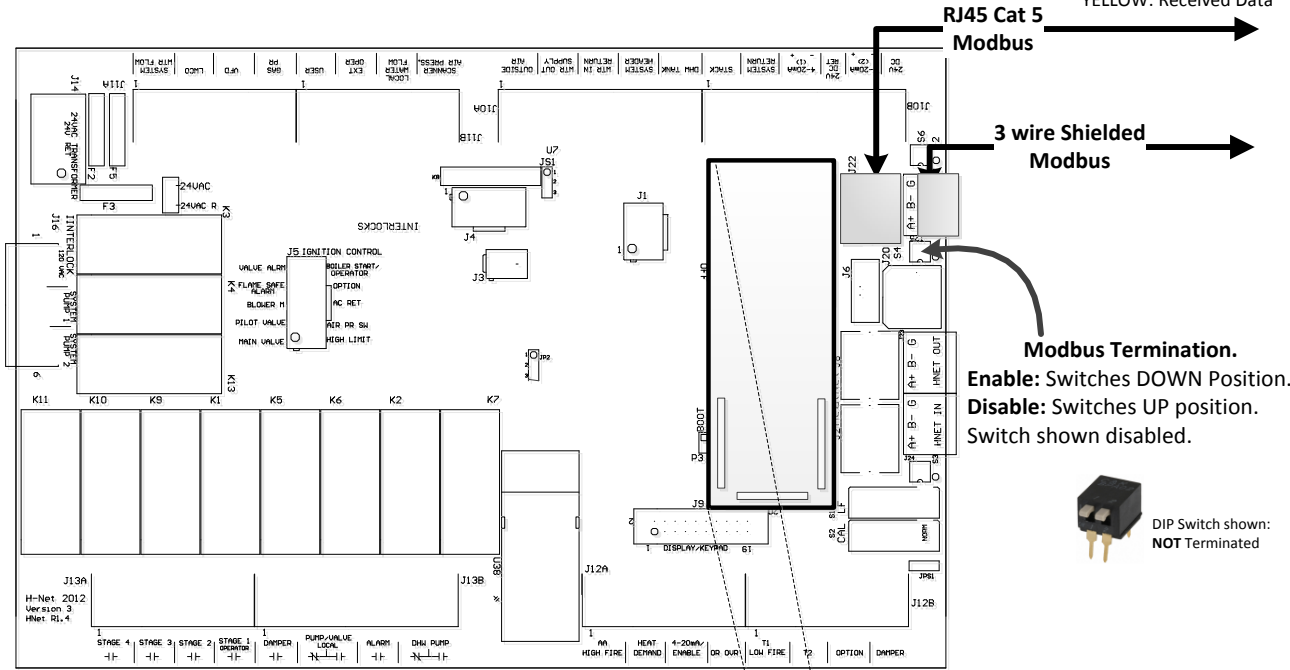

The pin headers are located on the control ('U' shaped) that the Protocessor bridge module plugs in directly. Align the sockets on the Protocessor with the pin headers on the control, then press into place. Communication from the Protocessor bridge to the H-Net control is also handled through the sockets.

Next, connect the BACnet or LonWorks network cable to the Protocessor module or configure the bridge using the software tools. Once connected use the DIP switch to enable termination.

RJ45 Configuration and IP connection

NOTE: Do not plug the Protocessor module in with power on or the Protocessor module may be damaged.

Protocessor Bridge Module Plug-in. LonWorks or BACnet bridge which Can be used instead of the MODBUS input.

Shielded/Twisted Pair Connection (MSTP/LonWorks)

Additional Bulletins and Instructions for Configuring BACnet or LonWorks are available on the website.

Figure 33 Relays, Interlocks and Boiler Status

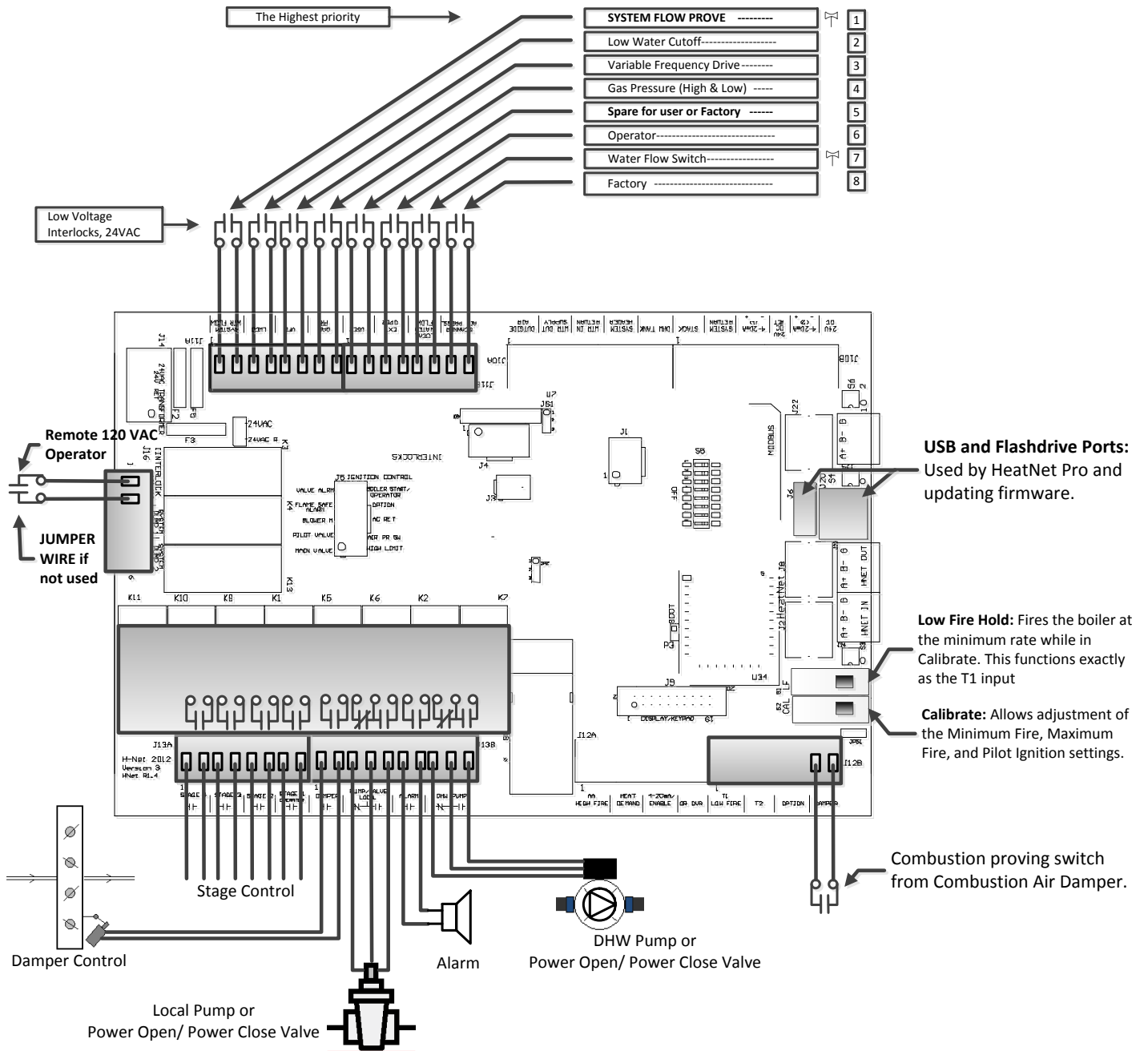

Figure 34 Temperature sensors

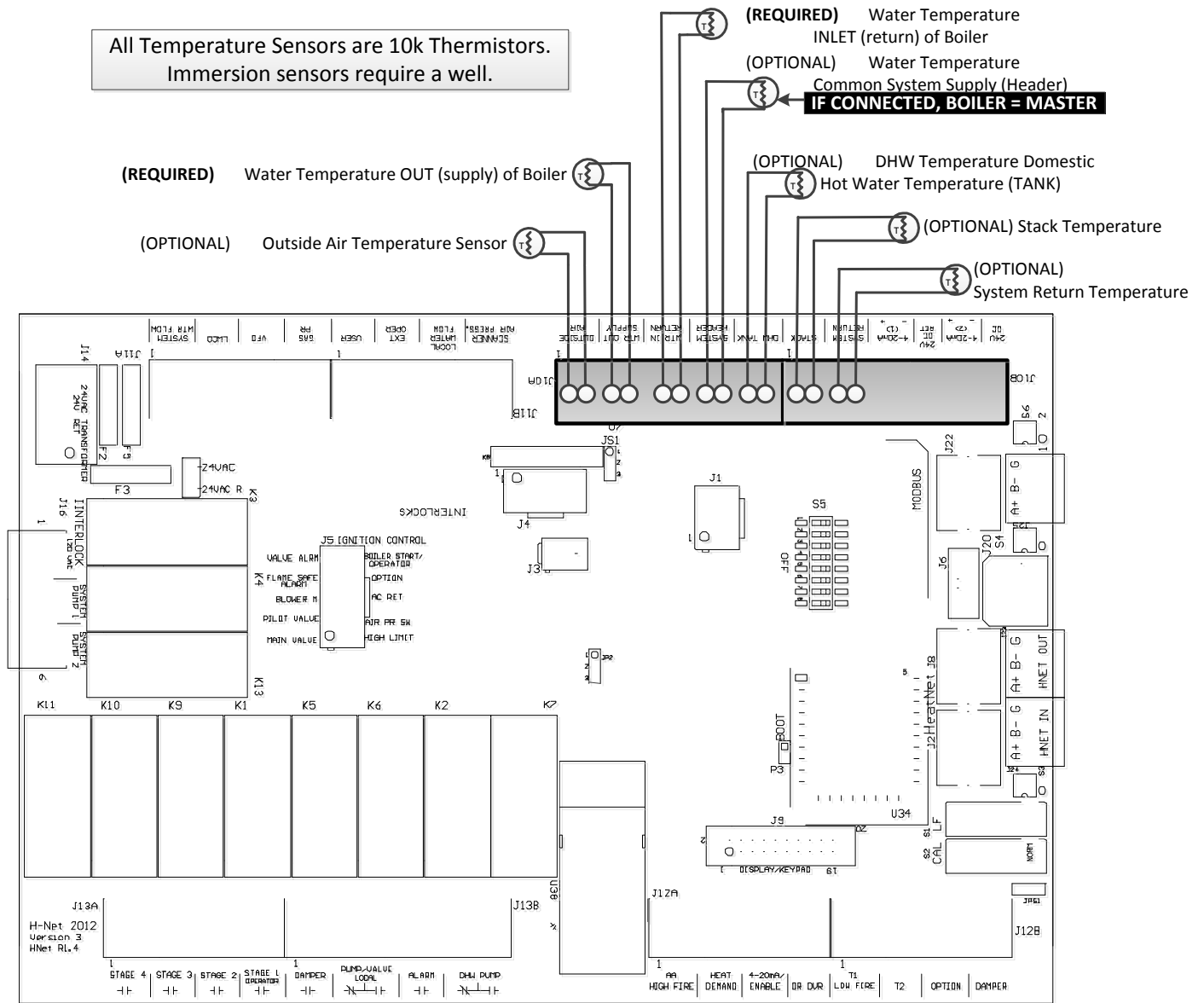
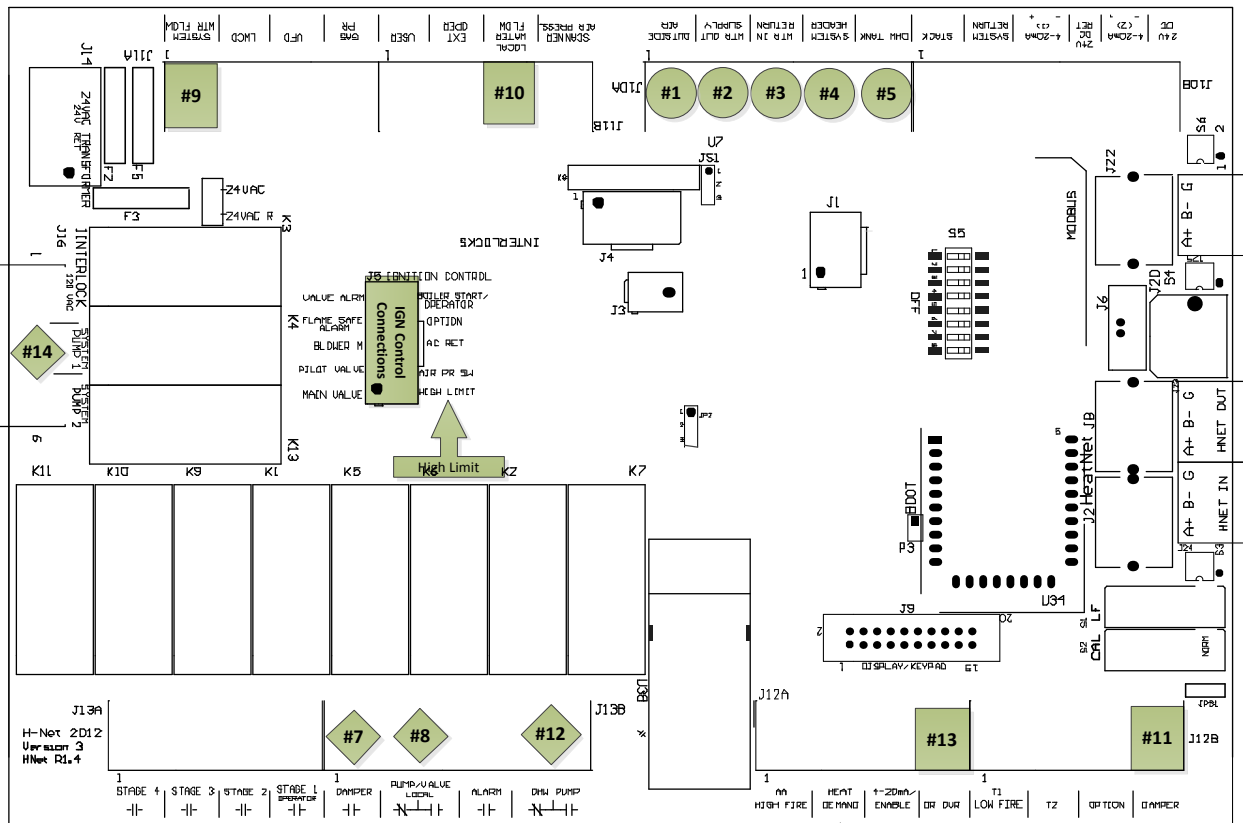
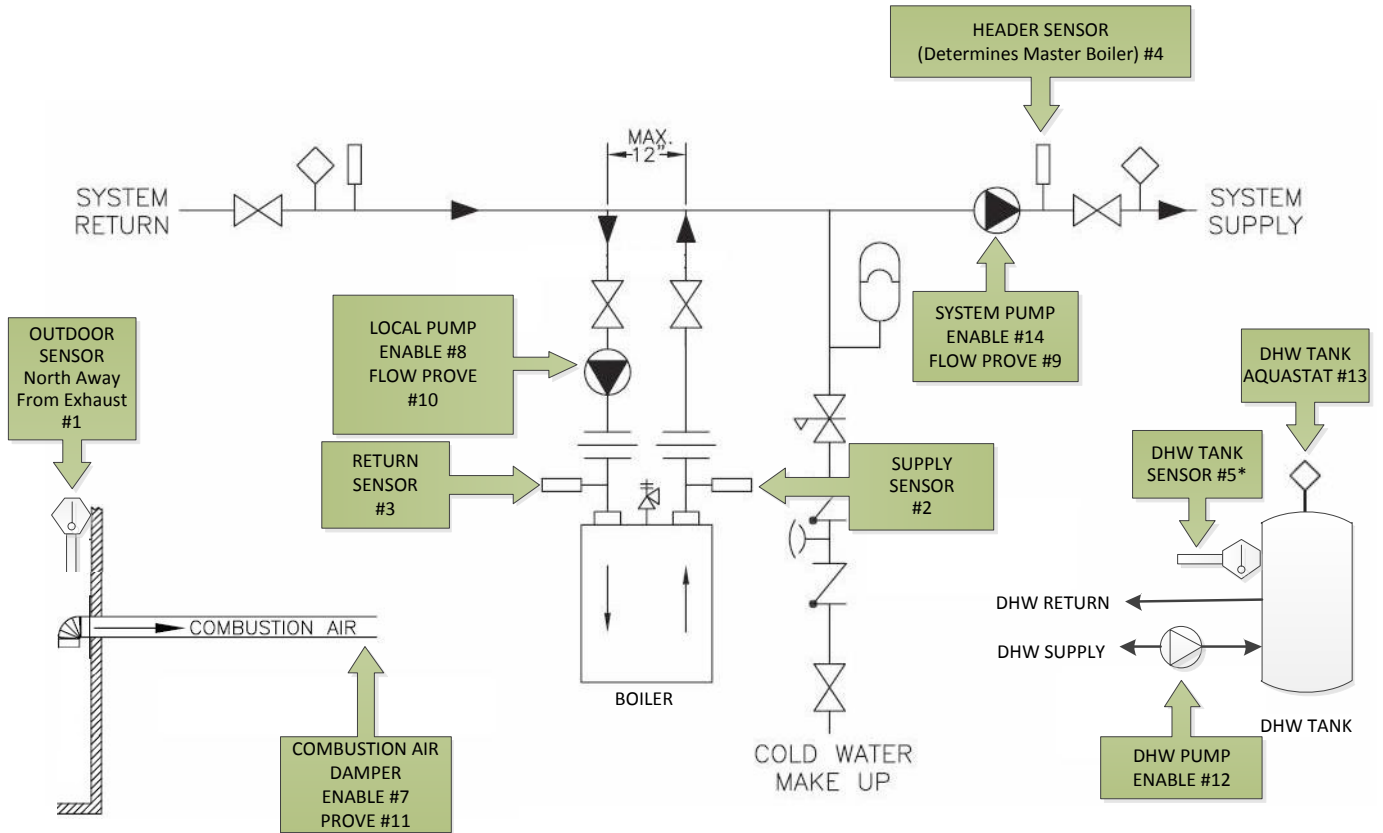

Figure 35 Typical Single Boiler System



*Note: When using DHW MASTER? YES, a Heat Demand signal must be used to activate the system.

Figure 36 Using a 4–20ma signal for direct modulation

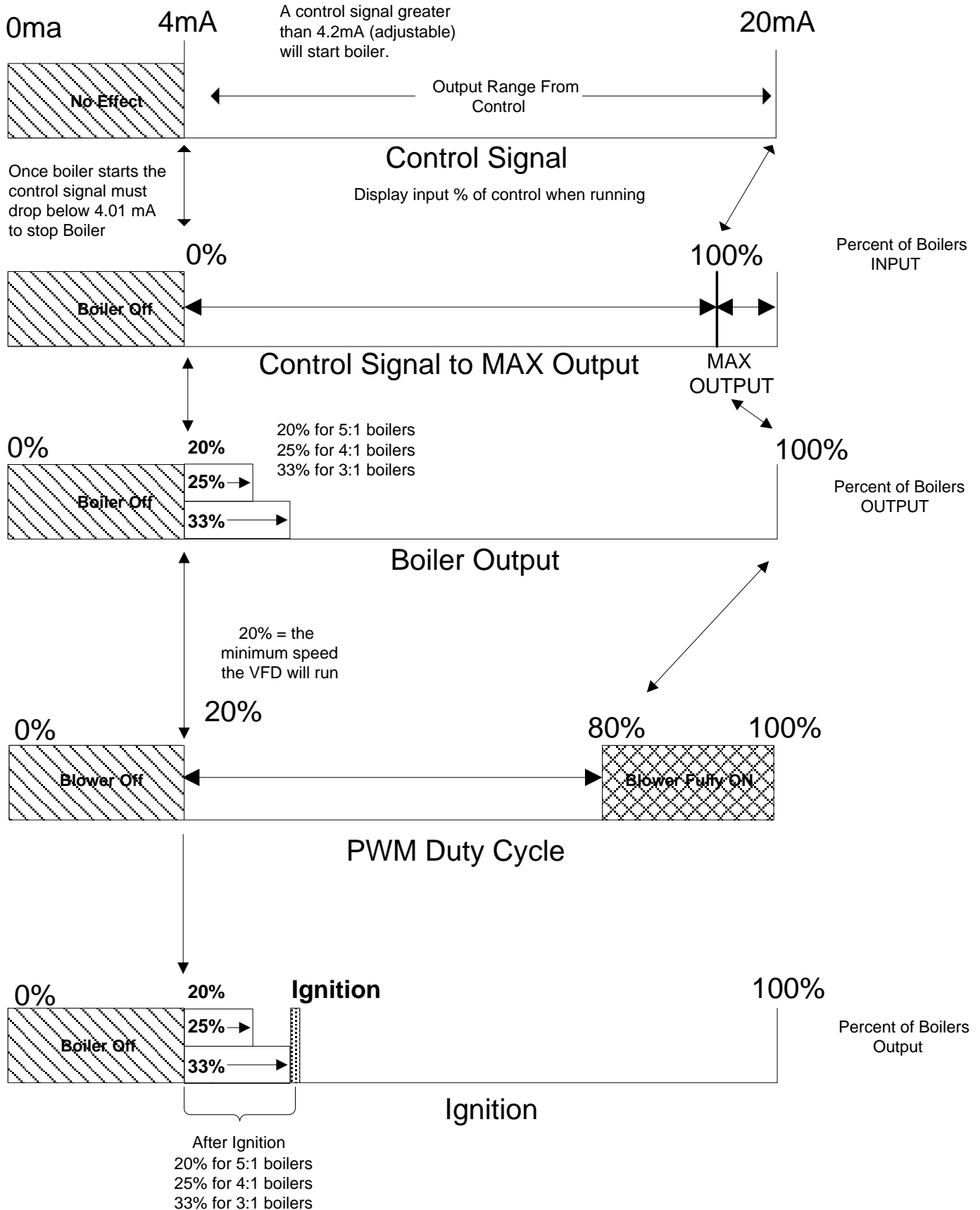

Figure 37 Common system damper wiring

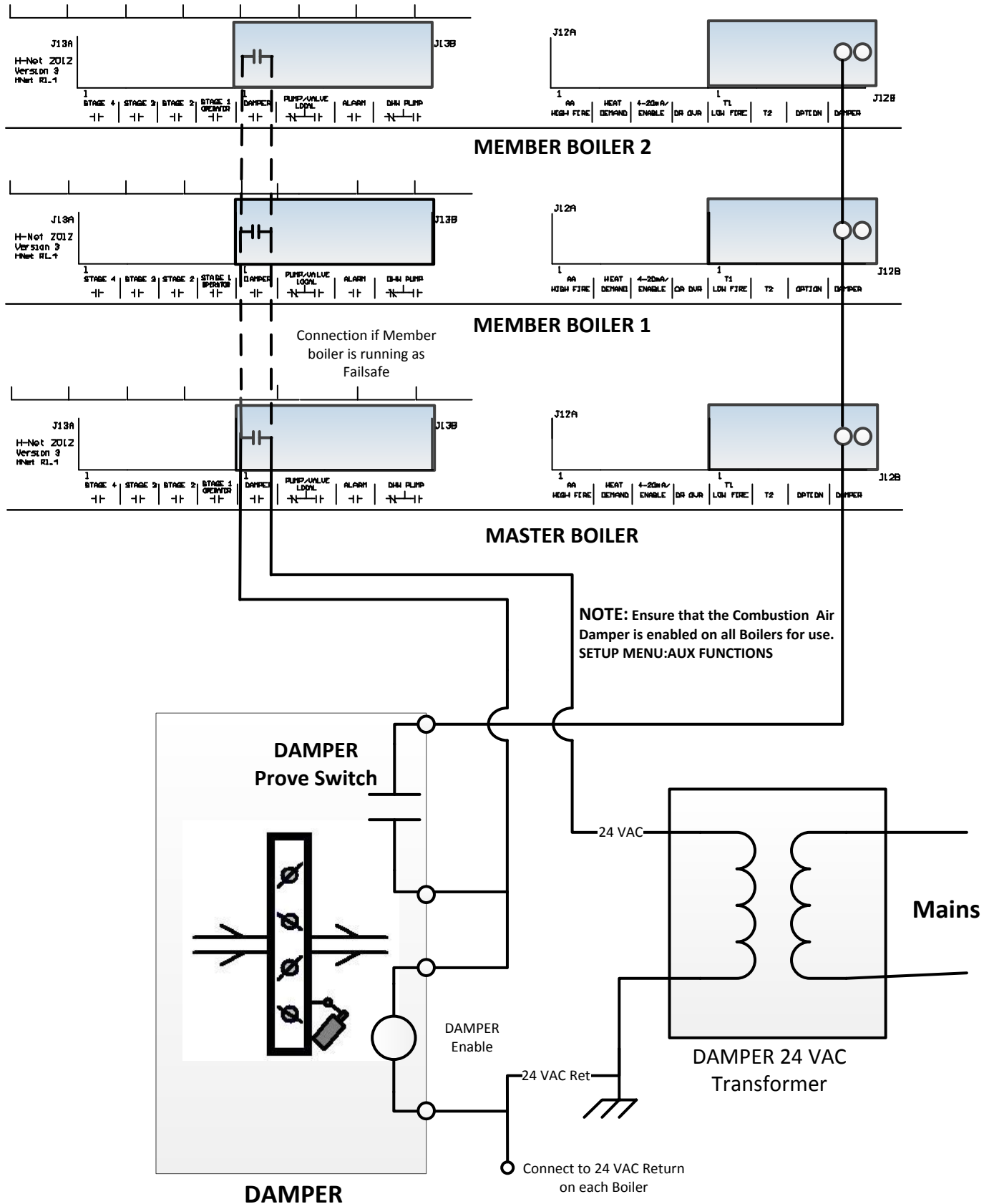
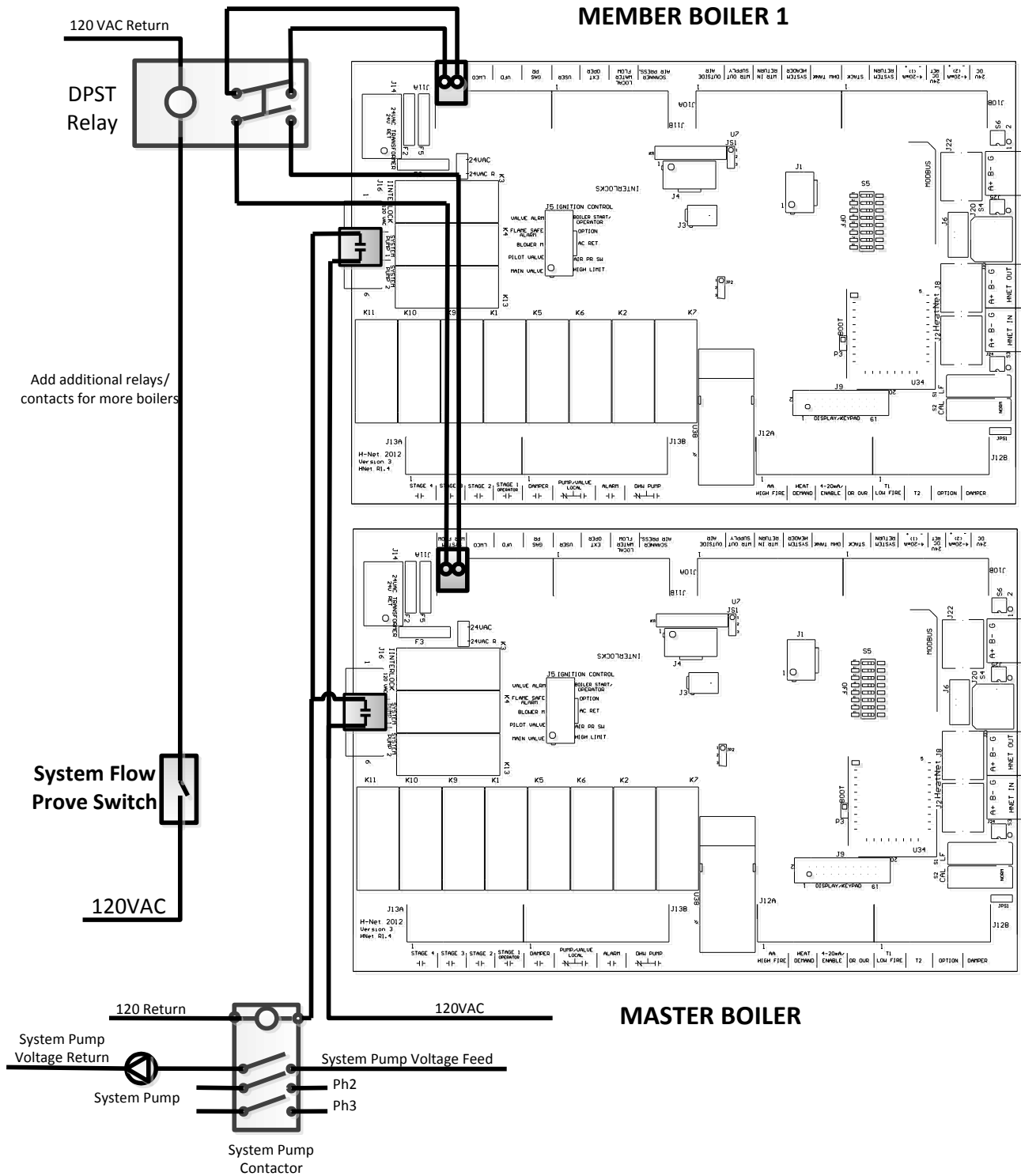

Figure 38 Failsafe common system pump wiring



Calibration

NOTICE The calibration of the KN-Series boiler should only be performed by a licensed technician.

To enter the calibration menus, place the S2 switch on the main control board to the CAL position.

Be sure to set this switch back to NORM when the calibration is complete, otherwise no external control inputs will work (except T1-T2), the display will always indicate CALIBRATE and some of the runtime temperatures will not be displayed.

The MIN VFD setting, the MAX VFD setting, and the Ignition setting can be adjusted in the calibration displays. The values can be changed while running **ONLY IN MINIMUM FIRE** (any, but only one of the T inputs closed). Prior to ignition, the values may be changed, but the blower will not operate.

NOTICE The Low Fire Hold switch is located near the Calibration switch.

Press the arrow keys until MIN VFD is shown in the display, along with the minimum percentage value at which the boiler is to run at min fire. While in Standby (no call for heat on inputs), the minimum percent may be preset. To set the minimum rate while running, any (1), and only (1) of the (T) inputs must be closed in order to set the boiler to MINIMUM fire. Press the SELECT key for approximately 1 second. The Percentage value will start flashing, indicating that it can be adjusted. Adjust the Minimum value to the desired setting using the arrow keys. The Minimum setting is clamped to its lowest rated setting and cannot be adjusted below this. Once you are done with this setting, press the SELECT key until the value stops flashing. The new setting is now saved.

Press the Arrow key to select the IGNITION percent. The Blower speed will be set here to provide the rate for ignition. While in Standby (no call for heat on inputs), the Ignition percent may be preset, before firing the boiler. To set the ignition rate while running, any (1), and only (1) of the T inputs must be closed Pressing the SELECT key here will cause the IGNITION setting to flash and the boiler will ramp to the ignition setting. Adjust it using the arrow keys and then press the SELECT key until the value stops flashing. The new setting is now saved.

Log Entry

The KN-Series H-Net control contains a log that records the major activity (events) in the operation of the boiler. This activity includes interlock faults, boiler starting and stopping events, power cycles, misc. faults, and types of calls-for-heat (control inputs). Setting the time clock to an accurate time and date is very useful when events are recorded, since the control will time stamp each snapshot. If the system is configured to run with HeatNet, then only the Master boilers SYSTEM TIME needs to be entered. The Master will then set the time on all Member boilers.

The log is primarily used as a troubleshooting and diagnostic tool, but may be used as a performance tool to view run time cycles.

An event in time of the boiler's state is presented via multiple screens. Each screen event can be stepped through using the arrow keys.

The top line displays the time and date the event occurred. In the top right corner, the event # is displayed so that easy indexing can be done using the arrow keys. The second line displays the Water temperature of the boiler's output (supply) and the Setpoint temperature. The third line displays the Outside Air temperature, and the Modulation. The bottom line is used to record the control state of the boiler.

The control state is defined as the Boiler(s) that is running, the Circulator Pump state, and the ignition condition (Main Valve, Pilot Valve, Blower, and the Ignition alarm). The #

of boilers that are displayed is limited to 7 if the boiler is the MASTER. If boilers #8 and up need to be viewed, the *Boiler Control Pro* software will need to be used. The Last 2 characters on the fourth line indicate the heating mode the control is in. The modes are:

- NC = No Call for Heat
- HD = Heat Demand (MASTER and Local modulation control using PID control, MASTER and MEMBER)
- RM = Remote Modulation from 4-20ma input
- HF = High Fire from ALL T-inputs closed or the AA input
- 1T = Low Fire from any 1 T-input closed (Low Fire or High Fire)
- 2T = Mid Fire from any 2 T-inputs closed (Low fire or High Fire)
- OP = Option input Active
- HT = H-Net Control using the Heat-Link communications cable

The bottom line is also used to indicate an interlock or limit that has tripped. It may also indicate a sensor that has failed. When this occurs, the normal bottom line in the display is not visible, and the sensor fault is displayed.

For details on messages that appear on the fourth line: See *Appendix B*.

The log may also be viewed using HeatNet Pro or HeatNet Online.

Figure 39 Log entry display

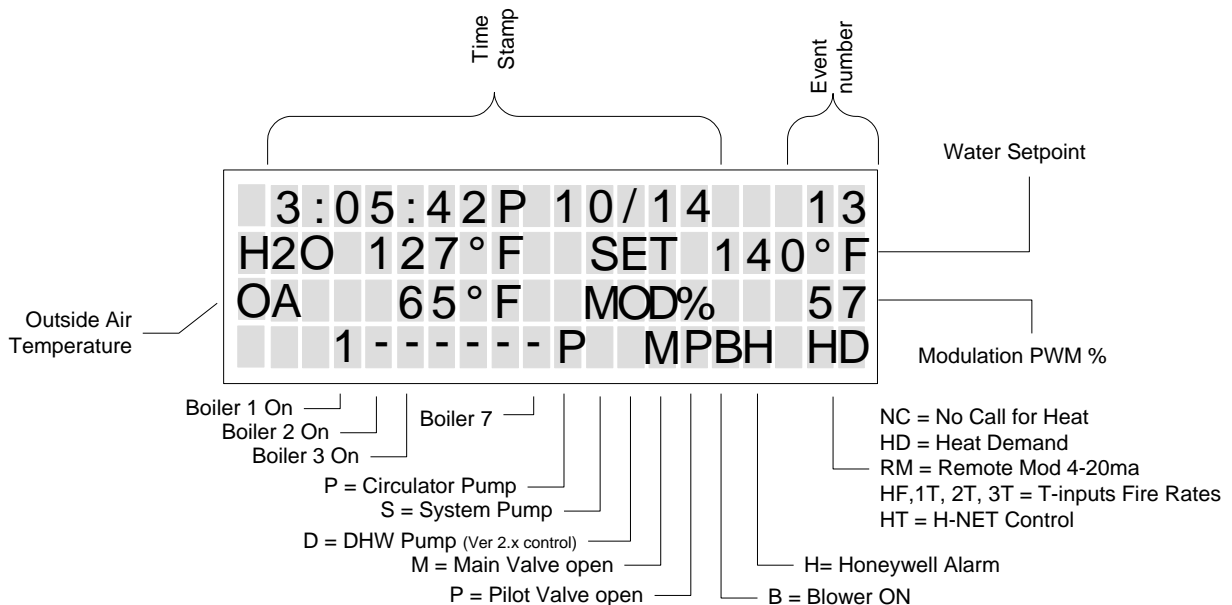

Default Settings & Menu Item Descriptions — SETUP

MENU	DEFAULT VALUE	RANGE	DESCRIPTION
BOILERS			
# OF BOILERS	1	(1-16)	If operating as a member.
LEAD BOILER #	0	(0-16)	# of first boiler to run, determines the fire order in rotation. A
LEAD BOILER #	0	(0-16)	# of first boiler to run, determines the fire order in rotation. A 0 disables the Lead Boiler function. Firing Mode determines lead.
HEAT BAND	30 °F	(2 -50 °F)	Differential temp around setpoint used to stage boiler(s) OFF/ON
HNT	M	(M-16)	This line displays the boilers auto detected by H-Net. While M is the Master boiler the numbers are the H-Net address of each boiler from 2–16.
SETPOINTS			
LOCAL SETPT	160 °F	(40-220 °F)	Local setpoint used to maintain temperature of SETPT SOURCE
OPERATE LIMIT	215 °F	(45-230 °F)	When running as a member, boiler shuts off when supply temperature reached. Boiler restarts at lower temp of OP LIM BAND or 10F whichever is lower
LOCAL SETPT	160 °F	(40-220 °F)	Local setpoint used to maintain temperature of SETPT SOURCE
OP LIM BAND	20 °F	(1-50 °F)	Limits external input % when in (OP LIM - OP LIM BAND)
SETPT SOURCE	AUTO	AUTO 4-20mA	AUTO = Local/ System/ WWS Setpoint is used 4-20mA input is mapped to a setpoint.
OUTDOOR AIR RESET			
OA RESET	OFF		Outdoor reset ratio (boiler water temp/outside air temp).
WARM WEATHER SD	NO		If set to YES, the boiler /system shuts down when the temperature exceeds the WWS SETPOINT.
WWS SETPOINT	68 °F	(40 – 100 °F)	Temperature at which boiler shuts down, operation is below this. If boiler is running using either OA RESET or WWS and the OR OVR input is closed the OA RESET slope is overridden and runs at local setpoint until OR OVR input opens.
SET OA SETPOINTS			
WATER TEMP At HIGH OA TEMP	140 °F	(60 – 190 °F)	Boiler water temp setpoint when OA temp is at HIGH OATEMP These four setpoints determine the OA reset slope.
WATER TEMP At LOW OA TEMP	10 °F	(-35 – 40 °F)	Header/Supply setpoint when OA Temp is at LOW OA TEMP
PUMP OPTIONS			
SYSTEM PUMP			
POST PRGE TIME	2 minutes	(2-60min)	Time in minutes to keep system circ. pump on after boiler stops
PUMP ROTATION			New menu screen
ROTATION:	NONE	NONE SYS HRS PUMP HRS	
SYSTEM PUMPS	1	1 or 2	The number of system pumps connected.
ROTATE TIME	240 hrs	1-1000 hrs	If ROTATION is set to SYS HRS, ROTATE TIME is used to switch pumps when this time expires. This time is measured against the actual time the system pump is enabled. This would include a post purge time.

			If ROTATION is set to PUMP HRS, ROTATE TIME is used to switch pumps when the pump's time difference is greater than ROTATE TIME. Whichever pump has the least time and is at least below the other (pump's time - ROTATE TIME) will switch to the enabled state. This selection is used to equalize run time on the pumps.
MORE MENUS			New menu screen follows.
ZERO RUNTIME	PUMP1	PUMP1- PUMP2	This menu allows the clearing of a pump's runtime counter. Discretion is advised in clearing only one pump's hours after replacement and then using ROTATION set to PUMP HRS. This would cause the pump whose runtime was cleared to run until it's time exceeded the other older pump.
PUMP1 TIME		0-999999 hrs	Indicates how many hours the HeatNet control has accumulated on pump 1.
PUMP2 TIME		0-999999 hrs	Indicates how many hours the HeatNet control has accumulated on pump 2.
ALWAYS ENABLED	OFF	ON/OFF	ON = Pump never shuts off. Used when there is only 1 system pump in the system.
SUMMER PUMP JOG	OFF	ON/OFF MON-SUN	Used with Outdoor Reset, Jogs the local and system pump(s) for POST PRGE time when system is in summer shutdown. Jog once a week @12:00 AM. The menu item OVR ENAB IN WWS and ALWAYS ENABLED must be set to OFF for the jog function to work,
OVR ENAB IN WWS	OFF	ON/OFF	Priority mode for the system pump while in Warm Weather Shutdown. ON: The system pump is allowed to run in WWS when the OR OVR override input is closed. When set to OFF, the system pump will not come on while in WWS with the OR OVR override input closed. Enabling this feature disables the SUMMER PUMP JOG.
LOCAL PUMP			
DELTA TEMP ENAB	OFF		ON: Use Delta temperature to shut pump off when temperature across boiler is less than DELTA TEMP setting.
DELTA TEMP	10 °F	(2 – 50 °F)	
POST PRGE TIME	2 minutes	(1-60min)	Time in minutes to keep local circ. pump on after boiler stops
ALWAYS ENABLED	OFF		Pump never shuts off.
PUMP/VALVE OPTIONS			
MASTER PUMP/VALVE			
REMAINS ON:	OFF	ON/OFF	ON: The master boiler will keep its pump/valve on when no boilers are running. Prevents deadheading the system flow.
LOCAL PUMP VFD	OFF	ON/OFF	ON: Outputs a 0-10VDC or 4-20mA signal from J4 pins 1 & 5 that is proportional to the fire rate of the boiler. Connect to a VFD controlling a Local pump.
FLOW PROVE	10s	10-240 sec	This is an adjustable flow proving time to allow slower valves to open before proving flow.
NIGHT SETBACK			
SETBACK ENTRY	1	(1 – 4)	Four setbacks to adjust setpoint during a time period
ENTRY IS	OFF		Enable or disable the use of this setback
SETBACK	20 °F	(0 – 50 °F)	Temporarily subtracts this temp from the setpoint
START DAY	MON		Day of the week to begin setback or a day range
TIME	12:00AM		Time to begin setback
END DAY	MON		Day of the week to end the setback or a day range

TIME	12:00AM		Time of the day to end the setback
OPTIONS			
TEMP SCALE	° F	(F or C)	Fahrenheit scale is default
KEY CLICK	ON		Beeeps when a key is pressed
SKIP PASSWORD	ON		Disables the Password
BRIGHTNESS	50%	(25, 50,75,100)	Four levels of display brightness, lower for longer life of the display
LOG/RUNTIME			
RUN HOURS			Displays runtime hours. Total time the main valve has been open.
DATA LOG ENTRY			Displays the current entry in the data log
SIZE			Displays the current size of the log in entries
BOILER CYCLES			Displays completed boiler cycles. Incremented when the main valve turns OFF after it has been ON. Does not include attempts to light.
AUX FUNCTIONS			
COMBUST AIR DAMPER			
TYPE		LINKED/Common INDEPENDENT	The LINKED/Common setting allows one common damper to be used and controlled by the Master Boiler. All Member boilers must have their damper prove inputs wired as per Figure 37, Common system damper wiring, page 57. Also see Section: <i>Optional Features: Auxiliary Function Options</i> INDEPENDENT: Individual dampers are in controlled by their respective boiler.
IN USE?	YES		If set to YES, then OUTPUT RELAY K5 can be used to control a combustion air damper. The Master can control a common system damper or an individual damper. Members control their respective damper independent of the Master. Relay K5 is used to enable the combustion air damper. See Figure 37, Common system damper wiring, page 57. Needs to Prove the damper is open.
INPUT:	J12B.7 DAMPER		The damper prove input is dedicated to connect at J12B terminals 7 and 8. If using a common damper refer to the common damper wiring diagram.
PROOF TIME	2:00	(0 – 4min)	This is the proving time in minutes for the combustion air damper prove switch. It is sensed at J12B Pin 7. If the damper faults, a retry will occur every 10 minutes in attempt to open the damper. When using J12B in a common damper configuration, wiring is done beginning with the Master boiler. J12B Pins 7,8 are connected to the prove switch of the combustion damper. Pin 8 is supplying 24 VAC and pin 7 is the sense input. A second wire is connected to J12B pin 7 of the Master and the other end connected to the first member boilers J12B pin 7. If another member boiler is present, connect another wire to the J12B Pin 7 terminal of the first member and the other end to the second member boiler J12B pin 7. Continue this method for each additional boiler.
ALARM SILENCE			
ALARM SILENCE IN USE?	YES		This menu allows the configuration of the Alarm Silence switch. It can be disabled so that the Alarm Silence switch cannot silence the alarm until the alarm is cleared; ALARM SILENCE = NO. The default value is to enable the ALARM SILENCE switch. Holding down the BACK and SELECT keys at the same time may also be used to silence the alarm.
INPUT =	J10B STACK		If a stack sensor is used, holding down the BACK and SELECT keys at the same time is the only way to silence the alarm.
FAILSAFE MODES			
RUN IN LOCAL IF: H-NET COMM LOST	OFF		If this entry is set to ON and the Member boiler does not see any communications coming from the Master boiler, this boiler will run

			in LOCAL. The boiler will continue to run in LOCAL until communications are re-established or this entry is set to OFF.
LOW TEMP	OFF		This entry may be set to one of the temperature sensors: SUPPLY, HEADER, RETURN, or turned OFF (default). If this entry is set to a sensor and the temperature falls below TEMP, the boiler will automatically start and run the water temperature up to the LOCAL Setpoint and then shut OFF.
TEMP < 40F	40 °F	35-200 °F	This is the temperature that the selected sensor must fall below for the boiler to start.
MENU	DEFAULT VALUE	RANGE	DESCRIPTION
HEAT EXCHANGER			
ALARM TYPE	FAULT	FAULT/WARNING	FAULT will stop the boiler when the Delta T has exceeded its setting. WARNING will allow the boiler to continue running, but produce the Warning message.
EXCHR DELTA T	AUTO 60 °F	AUTO 1 to 120 °F	Settings are AUTO if running DELTA HIGH/LOW protection. This is the maximum differential temperature the heat exchanger can see before the LIMIT RATE feature is activated, and a log entry is made.
LIM-> HALF RATE	NA YES		Not Available when operating in DELTA HIGH/LOW protection. Limit to Half Rate: When set to YES, and the maximum differential temperature (delta T) has been exceeded, the fire rate called for is cut in half. In other words: if we are calling for 80% modulation and have exceeded the delta T, the boiler will only fire at 40%. The delta T needs to drop 10F below the maximum delta T to reset this limit. The message “½ INPUT” will be displayed on a member boiler and a Master Boiler will display the Modulation % for the system even though it is running at ½ of this rate. This method helps protect the heat exchanger from damage due to excessive delta T’s. If this Master boiler is running
SEND RETURN	RETURN	RETURN, SYS RET	This setting is used by the Master boiler to select which Return sensor temperature to send to all Member boilers. The Return temperature will then be used by the Member boilers (usually non-condensing) to determine if they can be called by the Master to run. If a System Return sensor is available on the Master, set this setting to SYS RET. If only a Return sensor is available, set to RETURN.
TEMP DISAB	OFF	SYS RET, RETURN, OFF	This setting is used by a Member boiler (primarily a non-condensing type) to determine which return sensor to look at when determining if it is safe to fire. Its purpose is to keep non-condensing boilers from firing in a condensing mode. SYS RET the boiler will use the Return temperature sent from the MASTER boiler. RETURN the boiler will use its own Return sensor. If it is set to OFF, then this feature will not be used. If a sensor is selected, then the Boiler will determine if the Return sensor’s temperature is below the TEMP< XXX setting in the following menu. If the Return temperature is lower, the boiler will take itself offline from the Master. Informing the Master that it can not run. The message “ blr offline ” will be displayed in the Status

			screen.
TEMP<140F	140	135F – 200F	Setting determines where the TEMP DISAB return sensor’s threshold temperature disables the boiler from firing.
EXTEND PP TIME:	0s	0-600s	<p>This time may be used to remove condensation that is still present on the heat exchanger after the boiler has finished running. The time may be adjusted to 600 seconds(10 minutes). Unlike the 10 second fixed post purge time the extended post purge time may be interrupted by a call for heat.</p> <p>If the extended post purge is active, an ‘*’ will be displayed next to “STANBY *”. This indicates that the boiler is still ready to run, but is completing an extended post purge. As always, the STATUS screen will display the meaning of the ‘*’. In this case: EXTEND PP.</p>
DOMESTIC HOT WATER			
DHW BOILER?	NO	NO, LOCAL, MIXED	<p>Setting this value to LOCAL or MIXED enables the DHW PID. Setting this value to NO disables the DHW PID.</p> <p>LOCAL allows the boiler to run in DHW locally off of its own sensor or thermostat input. The boiler could be configured to run as a space heating boiler that is controlled by a Master. It would also monitor a tank or DHW call and disconnect from the Master to provide local DHW heat.</p> <p>MIXED allows the boiler to be configured to run as a space heating boiler and a DHW boiler that is controlled by a Master. This method would use both the space heating PID and the DHW PID to simultaneously control space heating and DHW heating.</p> <p>NO, turns off the DHW PID, but still allows control of the DHW pump and DHW setpoint for backwards compatibility.</p> <p>*Note: If the System is configured to use the OR OVR input to override the heating setpoint with the DHW setpoint, the DHW PID is not used. Since this method does not use the DHW PID, the DHW BOILER setting should be set to NO. The DHW SETPOINT, POST PURGE, LOCAL PUMP OFF, LOCAL DELAY, and PURGE TO THE: may need to be set if this method is used. This method does allow configuring the LOCAL and DHW pumps.</p>
DHW SETPOINT	160 °F	40 – 200 °F	Setpoint that the boiler/system will target when a call for DHW.
LOWER DHW DIFF	5 °F	1 – 30 °F	DHW SETPOINT – LOWER DHW DIFF: if the DHW water temperature is less than this temperature, the Boiler/System will enter DHW Heating mode if DHW BOILER? is set to LOCAL or MIXED.
UPPER DHW DIFF	3°F	1 – 30 °F	DHW SETPOINT +UPPER DHW DIFF: if the DHW water temperature is greater than this temperature, the Boiler/System will begin shutting off DHW boilers if the DHW BOILER? is set to LOCAL or MIXED
DHW PRIORITY	NO		If the DHW PRIORITY is set to YES, then when there is a call for DHW, the system pump shuts off. If NO, the system pump stays on.
POST PURGE	120s	0-600 secs	This is the time that the DHW relay remains on after the DHW call ends.
USE SENSOR?	NO		If this entry is set to YES, the DHW 10k Sensor is looked to for controlling DHW water temperature. If set to NO, A thermostat is used.
Sharing	OFF	OFF, NO CYCLE, CYCLE	NO CYCLE allows the boiler to perform as a space or DHW heating boiler. DHW always has priority and will override (steal) a space heating boiler that is running when none are available to perform

			<p>DHW heating. When this happens, the boiler will not shut down, but keep running during the change from space heating to DHW (Hot Swap). Once the DHW cycle completes, the boiler will shut down and wait to be called for space heating again.</p> <p>CYCLE allows the boiler to perform as a space or DHW heating boiler. DHW always has priority and will override (steal) a space heating boiler that is running when none are available to perform DHW heating. When this happens, the boiler will shut down and exit the space heating mode. The boiler will then re-start as a DHW heating boiler. Once the DHW cycle completes, the boiler will shut down and wait to be called for space heating again.</p>
LOCAL PUMP OFF	NO	NO, YES	<p>YES will shut off the local pump/valve when DHW heating is in effect. If the boiler is running in space heating mode, the LOCAL DELAY will be in effect before the local pump/valve shuts off.</p> <p>NO both the local and the DHW pump/valve will be enabled during DHW heating.</p>
LOCAL DELAY	10 Seconds	0-255 seconds	<p>Seconds is the time in seconds that the local pump/valve will remain on after the DHW pump/valve is enabled before shutting off. This is part of the changeover process when the boiler was running in space heating mode and now needs to provide DHW heating.</p> <p>This timer may also be used for race conditions when operating valves. The Local Pump Flow Prove time would be used to prove flow, but with valves, the local valve may still have flow when the DHW valve begins to open. This would cause a flow fault when the local valve closes and the DHW valve still has not opened.</p> <p>The way it works, is that these timers work in parallel, but this timer only counts down when flow is present. It stops counting down when flow stops, but will not cause a flow fault until its time expires. The Local Pump Flow Prove timer counts down, but normally when flow occurs, it proves and the boiler is allowed to run. This local delay timer would then take over instead of allowing the boiler to run, and wait until its time expires before allowing the boiler to start. This timer proves that there is flow, whether interrupted or not, for x(setting) seconds. If pumps are used, this value can be set to a few seconds.</p>
PURGE TO THE	TANK	TANK, SPACE	<p>TANK will keep the DHW pump/valve enabled for the DHW POST PURGE time thus purging some of the boilers heat into the tank.</p> <p>SPACE will turn off the DHW pump after 5 seconds and enable the local pump/valve when a DHW heating cycle completes. This allows dumping some of the remaining heat from the boiler into the heating space (dump zone) and preventing the tank from overheating.</p>
HYB SENSOR	OFF	OFF, SUPPLY, DHW, RETURN	<p>Hybrid mode sensor for DHW method 5A</p> <p>OFF This sensor is selectable for DHW Method 5A only.</p> <p>SUPPLY In DHW Method 5A will maintain the DHW setpoint at the supply sensor when the OR OVR input is closed.</p> <p>DHW In DHW Method 5A will maintain the DHW setpoint at the DHW sensor when the OR OVR input is closed. This sensor is optional and needs to be added. It can be moved around and placed in the Tank, pipe feeding the tank, or other</p>

			location to maintain a setpoint at that location. RETURN In DHW Method 5A will maintain the DHW setpoint at the RETURN sensor when the OR OVR input is closed.
SYSTEM CLOCK			
TIME			This time needs to be entered at first turn-on and in the event that power has been lost for more than 3 days. The time is required for an accurate Night setback, log entry time-stamp, and fault time stamp.
DAY OF WEEK			
MONTH			
DAY			
YEAR			
PRESS SEL TO SAVE			The SEL key must be pressed after all time values have been entered to save all time values at once.

Default Settings & Menu Item Descriptions — ADVANCED SETUP

DISTRIBUTED CTRL			
CONTROL	H-Net		Displays method of operation: HeatNet (H-Net)
H-Net MASTER	YES		Auto detected, based on the HEADER sensor. If the HEADER sensor is present and is set to TYPEZ, the KN-Series control is run as a H-Net MASTER (YES). If the HEADER sensor is not TYPEZ, H-Net MASTER = NO.
MASTER TYPE	AUTO	AUTO, MIXED, DHW	Two PID controls are provided, one for Space heating and one for DHW heating. This menu item selects how they are to be used. The MASTER TYPE setting is used to determine if the MASTER control is to be used as a space heating control, a mixed DHW/space heating control, or just to perform DHW Heating. When set to AUTO, the boiler uses one PID control to provide space heating. When set to MIXED, the control will use two independent PID controls to provide space heating and DHW heating. When set to DHW, the control only uses the DHW PID control.
H-NET ADDRESS	255	(2 –16)	The local address is the address of a member device. This is normally in the range of 2 through 16. But if the KN-Series control is a MASTER, then the default address is 255. The H-NET ADDRESS # is synonymous with boiler #.
MODBUS ADDRESS	1	(1 – 247)	The MODBUS address is for communicating with Laptop, PC, or other MODBUS capable device, such as a Building Management System. It is the 2nd communication port reserved for host control.
MODULAR BOILER SET			
SPACE HEATING DHW HEATING			If the MASTER TYPE is set to MIXED, or the DHW BOILER? setting is set to LOCAL or MIXED, the MODULAR BOILER SET is duplicated for each PID. Select SPACE HEATING to set the ADD, SHED, MODULATE, and MOD MAX values for the space heating PID. Then select DHW HEATING to set the ADD, SHED, MODULATE, and MOD MAX values for the DHW heating PID.
ADD BOILER DELAY	10mins	(0 – 15min)	This is the delay time in 30sec intervals, before starting a new boiler. Boiler #1 is started immediately after a call for heat. If a second boiler needs to start, the ADD BOILER DELAY will need to expire before starting.
SHED BOILER DELAY	2mins	(0-15min)	This is the delay time in 30 second intervals, before stopping a

			boiler. A boiler is stopped immediately when the top of the heat band is exceeded. If a second boiler needs to stop, the SHEDBOILER DELAY will need to expire before stopping.
MODULATE DELAY TIME	10 secs	(0 – 60min)	This is the time the boiler remains in min-fire before it relinquishes control to the modulation % signal.
MOD MAX – LAST FIRE	70%	(25 – 100%)	<p>This value represents the maximum % of input on the boilers if all the available boilers are not firing. Once all boilers are firing, this clamp is removed and all boilers are allowed to modulate up to 100%. When this value is limiting the input an ‘*’ is displayed and the “INPUT CLAMP” message is displayed in the STATUS screen. This value is derived by: multiplying twice the minimum fire rate of the boiler with the least turndown (2* turndown(20% 5:1, 25% 4:1, 33% 3:1)).</p> <p>In mixed boiler size configurations, more than (2) boilers in a system, or when “bumps” in the temperature occur as boilers are added and subtracted, this value may need adjustment. The adjustments will help produce smooth temperature control when each boiler is started and stopped. This method ensures that, once a new boiler starts to fire, and holds its fire rate at the minimum setting, it does not add its BTU output to a boiler already firing at 100%. The boilers can not be fired starting @ 0%, but start at a minimum (example: 20%) and introduce a minimum amount of BTUs into the system. Section: SETUP & OPERATION</p> <p>The MOD MAX value is also applied when using the AA terminal for High Fire and when using the 4-20 mA input for direct modulation. When these demands for heat are used, the maximum modulation the boiler can obtain when first starting is equal to the; ADVANCED SETUP: MODULAR BOILER SET: MOD MAX – LAST FIRE:. The timer value ADVANCED SETUP: MODULAR BOILER SET:ADD BOILER DELAY is used in conjunction to limit the modulation for this amount of time. Once the boiler has fired and the ADD BOILER DELAY time expires, the full modulation is available. This change is a protective means for extending the life of the heat exchanger which may consistently be exposed to thermal stress.</p>
ADAPTIVE MOD			
MOD MODE	ADAPTIVE		If MODULATION MODE is set to ADAPTIVE on the Master boiler, the Master lowers the system modulation rate of all currently running boilers before a newly started boiler enters the Main Valve state. Upon entering the Main Valve state of a newly fired boiler, the Master waits the DELAY RELEASE time before allowing the PID to resume modulation control. With MOD MODE set to ORIG KN, The Master boiler keeps firing at the current modulation rate when a new boiler is added and lets the PID adjust modulation rate accordingly.
DROP DOWN	ON CALL		If drop down is set to ON PILOT and MOD MODE = ADAPTIVE, and when a newly added boiler starts, the system waits until it enters its PILOT state before bring the system modulation down. This allows for the system to prepare for the new energy that is to be introduced. If DROP DOWN is set to immediately, the system modulation is lowered as soon as the newly added boiler is called.
DELAY RELEASE	0s		<p>Once the Main Valve opens on the newly added boiler and the MOD MODE = ADAPTIVE the Master waits this amount of time before releasing the PID to control modulation. This allows for the newly added boiler to accumulate some soak time.</p> <p>This is a global delay controlled by the Master boiler. It is comparable to the MODULATE DELAY setting, but this is a local setting on each boiler.</p>

FIRING MODE			
MODE	TRUE		<p>LOFO: Boilers are fired Last On, First Off starting with Lead Boiler</p> <p>FOFO: Boilers are fired First On, First Off</p> <p>TRUE: Boilers are fired based on the runtime they report back to the Master boiler. Boilers with the least runtime are fired first and boilers with the most runtime are stopped first.</p> <p>MIXED: Different types of boilers can be mixed in a system and fired based on (2) Priority sets. Boilers are started and stopped within their Priority sets based on their runtime hours.</p>
MIN RUNTIME	10	(1-750)	When the firing rotation is based on runtime, this value represents the interval in hours of runtime before rotation occurs. Boiler to Boiler.
MIN OFF TIME	0	(0-10m)	This is the time in minutes that the boiler must remain OFF before it can be fired again. Very effective in dynamic systems to minimize short cycling of a boiler and force the call to the next boiler (with next shortest runtime if True Runtime is used)
FIRING PRIORITY:	2	1 or 2	There are (2) Priority settings used by the MIXED boiler rotation algorithm. Priority 2 is the default and lowest priority. Priority 1 Is the highest priority. A Priority may be assigned to a set of boilers which fires and rotates based on time and is independent of the other Priority set.
PREDICT START:	YES	YES/NO	<p>YES: Predicts the boiler restart point in the heating band while the temperature of the boiler is drifting down through the band. The purpose of this is to ensure the temperature remains in the heating band. It also minimizes temperature swings when the boiler is stopped and started at low inputs.</p> <p>This algorithm looks at the size of the band and at what rate the temperature is falling. It then calculates when to start the boiler (knowing its starting time) to ensure the boiler starts within the band. Once the boiler starts, the Add Boiler Delay time starts and continues to expire in and below the band. This ensures that another boiler does not start when it leaves the bottom of the band.</p>
BASE LOAD BOILER			
BASE LOAD BOILERS:	0	0-1	This setting works in conjunction with the ADVANCED SETUP: SYSTEM:OPTION setting BASE LOAD. Currently only (1) base load boiler is supported using relay K8
START	>MOD	(START>MOD, START<OA T, START>RET)	Used in Conjunction with DELAY TIME.
START>MOD	100%	(20-100)	The base load relay K8 will close when the Modulation is >%. .
START<OA T		(40-140)	The base load relay K8 will close when the OA temp is > T
START>RET		(60-150F)	The base load relay K8 will close when the Return temp is > T.
STOP	FIRST	(FIRST, STOP<MOD, START>OA T, START>RET)	
STOP<MOD	20% (20-100)	20% (20-100)	The base load relay K8 will open when the Modulation is <%.
STOP>OA T		(40-100 °F)	The base load relay K8 will open when the OA temp is > T.
STOP<RET		(60-150 °F)	The base load relay K8 will open when the Return temp is < T.
DELAY TIME	0	(0-60 minutes)	This setting allows a wait time before firing the base load boiler once the start condition is met.
SENSORS			
NOTICE Sensors can only be changed when there is no call for heat. The boiler must be in STANDBY.			
SENSOR #			The first (4) sensor #'s are reserved as: OUTSIDE AIR, water

			SUPPLY outlet, water RETURN inlet, and system HEADER temperature. If the HEADER sensor is used (TYPEZ), that boiler performs the tasks of the MASTER boiler. If the HEADER sensor is set to NONE, its function is the MEMBER. The next (3) sensors perform DHW, Stack, and System Return measurements.
TYPE			There are (4) sensor types: NONE = do not use this sensor TYPEZ = 10k thermistor PT = 1k Platinum (only for Stack temperature) ON/OFF = 5 volts supplied out to detect a contact/switch closure.
CALIBRATE			Placing a precision 10k (TYPEZ) precision resistor across the sensor input selected allows calibration of the sensor input. Do not select calibrate with the temperature sensing thermistor/PT connected. Doing this will cause significant temperature errors.
4-20mA INPUT			
ANALOG IN CHANNEL:	1	1 -2	There are (2) channels that may be configured for 4-20mA inputs or 0-10VDC inputs. They are labeled 4-20mA (1) and 4-20mA (2). The 4-20mA (1) input is used to direct fire a boiler or to remotely control the setpoint of the boiler. Analog channel (1) is the primary channel used for direct modulation and remote setpoint control. The 4-20mA (2) is a dedicated input used for metered input such as: Flow meters, etc.
CHANNEL MODE:	4-20mA	4-20mA or 0-10VDC	Type of input to use for the ANALOG IN CHANNEL selected above. The input may be changed from 4-20mA to 0-10 VDC. The dip switch S6 also needs to be set correctly in conjunction with this setting.
SET PARAMETERS?			
START SETPOINT	50 °F	50-220 °F	When using 4-20mA setpoint control in SETPOINTS:SETPOINT SOURCE. This is the temperature when a BOILER START signal (see BOILER START menu below). The Setpoint will then be mapped from 4mA -20mA and example default of: 50-220F
20mA SETPOINT or 10 V SETPT	220 °F	50-220 °F	This is the setpoint temperature when a 20mA or a 10 VDC signal is applied.
BOILER START	4.11mA Or 2.04V	3.71 - 5.0mA Or .01 - 2.50 VDC	This is the current value which will start the boiler. There is a .1mA or .25 VDC hysteresis value. So if the Boiler starts at 4.11mA it shuts off a 4.01mA.
PRIORITY	NORMAL		If the Priority is set to NORMAL, the boiler responds to its HEAT DEMAND inputs in the Priority that is outlined in the Control Methods section. If the PRIORITY is set to HIGHEST, The 4-20ma input responds at the highest Priority level (same as the AA input). This method may be used by an external control to override the HeatNet control and fire the boiler using this external control (external control override). This allows for complex DHW control systems where an external control can take over the firing rate for a DHW call, and direct modulate a boiler.
PASSWORD			
	AAAAAA		Provides a limited access for security, though restoring system defaults will reset the password to the value "AAAAAA"
COMMUNICATIONS			
BAUD	19200	1200, 2400, 4800, 9600, 19200, 38400	This is the Baud rate for serial communication from the MODBUS port. Selectable from 1200, 2400, 4800, 9600, 19200, 38400.
DATA FORMAT	8E1	8E1, 8N1, 8N2, 8O1	8 bits -Even Parity -1 stop bit, valid settings: 8E1, 8N1, 8N2, 8O1
SETPOINT TIMER	ON	ON, OFF	If set to 'ON', the setpoint timer is enabled and requires a periodic

			update of its value to keep from timing out and returning control to H-Net control. If set to “OFF”, MODBUS always has control and on a loss of MODBUS communications, H-Net does not assume control.
SETPT TIME	1 minute	1-240 minutes	This time is used to automatically reset the SETPOINT TIMER when any Modbus value is written. If it is set to 1 minute, a periodic write to one of the registers must occur within 1 minute otherwise the BMS Setpoint will revert back to the System/Local setpoint.
LOAD DEFAULTS			
FACTORY CAL?			Selecting YES will load just the factory calibration values: MIN VFD, MAX VFD and IGN VFD.
FACTORY RESET?	NO		Selecting YES will load all factory defaults except the Calibration values, HeatNet, Modbus addresses, and personality profiles for the boiler type.
CONFIG ?	SAVE	SAVE, RESTORE	Selecting SAVE will save all of the current settings in this table into a permanent memory location on the HeatNet control. This should be done prior to upgrading new firmware or when a job has been commissioned. Selecting RESTORE will restore all of the saved settings from the permanent memory location to this table.
BLOWER SETTINGS (Ametek Blower)			
ACCELERATE	3.0%/s	.1 – 10.0 %/s	If a signal is sent to increase the blower rpm, the blower’s acceleration speed will change at this rate until it’s rpm is equal to the signal sent. % per second. Setting this value too high may cause overshooting of the blower rpm and temporarily over firing of the boiler. Setting this too low will slow down the response of the boiler to get to setpoint.
DECELERATE	3.0%/s	.1 – 8.0 %/s	If a signal is sent to decrease the blower rpm, the blower’s deceleration speed will change at this rate until it’s rpm is equal to the signal sent. % per second. Setting this value too low will slow down the response of the boiler to get to setpoint. Setting this value too high may cause undershooting of the blower rpm and temporarily dropping below low fire of the boiler (Due to this condition, the deceleration rate is automatically decreased as the rpm approaches low fire).
SOFT START SECS:	2	2 – 4 seconds	In order to start the Ametek blower, the control signal must be applied to start the blower at a low rpm. If the low speed start time is too low the Ametek blower may not start and lock out with its current limit. This may result in the need for the boiler to be recycled. If this is to be avoided, the Stage 4 relay may need to be wired to the Ametek Blower’s contactor. Doing this will allow (3) attempts to restart the blower every 10 minutes. If the time is too high, pre-purge time of the blower is lost.
FLOWMETER			
FLOWMETER	NO	YES, NO	If a flow meter or flow control is to be used, set to YES
GLYCOL MIX	0%	0-100%	Any mix over 10% de-rates the flow by 30% (rule of thumb method). Example: if the LOWEST FLOW = 50 GPM, HeatNet will calculate a New Lowest Flow required to be 65 GPM. The LOWEST FLOW does not need to be changed, but is calculated to 65 GPM and that value is used by HeatNet.
INPUT TYPE	VOLTS 2	VOLTS (2), mA (2), BMS,	This setting determines where the flow values are originating. If set to Volts (2), then a Flow meter is providing a 0-10V signal on J10B 4-20mA (2). Ensure that S6 switch 2 is UP for 0-10VDC. If the setting is mA (2), then a Flow meter is providing a 4-20mA signal on J10B 4-20mA (2). Ensure that S6 switch 2 is DOWN for

			<p>4-20mA.</p> <p>If the INPUT TYPE is set to BMS, a Flow Limited or a Boilers Limited method can be used. With Flow limited a GPM value can be written to the BMS GPM Modbus register 40019 with a valid flow. If the Boilers Limited method is to be used, the number of boilers that the BMS would allow HeatNet to control is written into Modbus register 40020.</p> <p>See the Flow Options section for more details.</p>
SET PARAMETERS			
LOWEST FLOW	By boiler type	0-500 GPM	This is the automatic value loaded and will equal the lowest flow required for this boiler (it is adjustable). It should be equal to the lowest flow of the largest boiler in the system.
HIGHEST FLOW	0		Currently not used.
FULL SCALE	per Flow Meter	0-1600 GPM	Enter the value of the full scale reading on the calibration card that came with the flow meter.
Flow Factor		PPG	Currently not used.
SYSTEM			
CONFIGURE INTERLKS			The 24 VAC interlocks can be enabled or disabled for reporting.
LOAD FIRMWARE	NO		Enters the Load Firmware menu. Loading new firmware allows for upgrades and bug fixes to the HeatNet control. See the SOURCE section below or USB FEATURES section for help in loading new firmware. Check the http://www.knseries.com/ website periodically for firmware updates.
SOURCE	USB DRIVE	USB DRIVE, USB CABLE, SAVE FILE	<p>Selecting USB DRIVE will read the FIRMWARE directory on a flash drive and display any .hex files located there. Follow the on screen prompts and then select a file using the arrow keys. Once a file has been selected, a STORAGE LOCATION needs to be selected. There are (2) storage locations for the new file. Location 1 is used for normal updates and Location 0 is for the factory stored backup file. When the Storage location (default is Location 1) is selected the file will be loaded into a permanent storage memory location. Next, the control will reboot and copy this new program into running memory, reboot, load factory defaults, and then reboot again.</p> <p>Selecting USB CABLE requires connecting a USB cable and running the Firmware Update program from a PC. This process takes longer and requires a Personal Computer (laptop) to be taken to the boiler site. Again, follow the on screen prompts to down load the program into a storage location as done when using the above USB DRIVE loading menu.</p> <p>Selecting SAVE FILE will display the currently stored files in the storage memory locations. Use the arrow keys to select a stored file for copying to running memory. When SELECT is pressed the file will be marked so it will be loaded on the next power cycle. Power cycle the boiler to begin copying the file from stored memory to running memory.</p> <p>NOTE: to access the factory backup program, the P3 BOOT shunt on the control needs to be connected and the CAL/NORMAL</p>

			switch placed in the CAL position. If the control is power cycled in this condition, the factory program will overwrite the existing running program. If in the LOAD FIRMWARE menus, STORAGE LOCATION 0 will be an allowed storage location.
OPTION:	NO OPTION	NO OPTION DUAL FUEL BASE LOAD	<p>When set to DUAL FUEL, input T3/ RESERVED, OPTION input is used to control the DUAL FUEL OPTION relay via K8 contacts on J4.2 &.6. When set to NO OPTION the input T3/RESERVED, OPTION relay K8 on J4.2 &.6 is inactive.</p> <p>When set to BASE LOAD, the Option Relay K8 on J4.2 &.6 is used as an enable contact for a base load boiler. The J4.1 &.5 0-10vdc/4-20mA output is used to modulate the base load relay if it is of the modulating type.</p> <p>The limitation of the OPTION menu is that Dual Fuel cannot be used with a Base Load boiler.</p>
BOILER TYPE			
PRODUCT:	KN6	KN6-KN30	The product type allows configuration of the control for a product (and given a personality). This allows the control to be used/interchanged with many products. The following fields will be adjusted for the personality of the product.
CONDENSING	YES		This defines a boiler as condensing or non-condensing.
BTU IN	200,000		This is the BTU input rating of the boiler. This value is not used with this released version and is displayed only for reference. Future releases may incorporate this feature. Check the revision history sheet on the website.
BLOWER	VFD	VFD, AMETEK, EBM	This is the blower type associated with the product. This should not be changed manually. Due to earlier models of KNs using Variable Frequency Drives, this setting needs to be adjusted for Whirlwind (Ametek) models. The default is for a VFD.
MASS	MEDIUM	LOW,MEDIUM, HIGH	This defines the mass of the boiler. This value is not used with this version and is displayed only for reference and future applications. Check the revision history sheet on the website.
TURNDOWN	5:1	3:1, 4:1, 5:1	<p>This is the turndown of the boiler. For the KN-series the default is 5:1 and determines the minimum firing percentage. 5:1 = Min 20%, 4:1 = Min 25%, 3:1 = Min 33%.</p> <p>NOTE: The boiler must be set up for operation at this Turndown rate using the Calibrate settings. This TURNDOWN setting only controls the displayed percentage.</p>
ALTITUDE	< 2000FT	< 2000 FT, > 2000 FT, > 4000 FT	This is the Altitude in feet of where the boiler is installed. On Ametek Blowers it limits the blower output for low altitudes and allows a higher output at higher altitudes. This setting sets the upper range limit of the MAX VFD setting.

MODBUS Communications

The KN-Series control can be controlled using Modbus commands to Enable/Disable the boiler/system. A connection to the Console Modbus Port on the Communications board is required. The Master Boiler assumes the role of MEMBER, RTU, 192Kb, 8 bits, Even Parity, 1 stop bit, when connected to a BMS (Building Management System).

The Member Boilers should not be connected to a BMS system other than to view Read Only addresses. Refer to <http://www.knseries.com/> website for greater detail on communicating with Modbus, BACnet, or LonWorks protocols.

- Boiler01 = The Modbus connected boiler (Master or Standalone)
- Boiler02 = Member 2
- Boiler03 = Member 3
- ...
- Boiler16 = Member 16

Figure 40 MODBUS Input/Output Variables (Read/Write)					
Address	Name	Raw Data Type	Scale	Description	Valid Values/Range
40001	HeatDemand	1 bit unsigned	---	Heat Demand/Request. Setting the state member of this variable will put the boiler in heating mode.	0 = no heat demand 1 = heat demand
40002	SetpointTimer	16 bit unsigned	---	System Setpoint Timer The system setpoint timer and system setpoint work in tandem to externally control (i.e. a BMS - building management system) the operating setpoint. The setpoint (countdown) timer should be loaded with a timeout value (in seconds) prior to writing the system setpoint. When the timer reaches zero, the control assumes that the BMS is no longer operating and the local setpoint (saved on the control) is reloaded. This is a failsafe feature used to help safeguard the system in case of BMS failure. If the setpoint timer is not written, a default timeout value of 60 seconds is assumed.	0 – 65535 seconds
40003	Setpoint	8 bit unsigned	1.0	System Setpoint (see <i>SetpointTimer</i>)	40 - 220 °F
40004	OARResetEnable	1 bit unsigned	---	Enables/Disables outdoor air reset mode.	0 = disabled 1 = enabled
40005	OARSetpoint	8 bit unsigned	1.0	Outdoor air reset setpoint. Temperature at which boiler shuts down.	40 – 100 °F
40006	OARHighWaterTemp	8 bit unsigned	1.0	Boiler water temperature setpoint when outdoor air temperature is at the high outdoor air temperature setpoint (OARHiAirTemp).	60 – 190 °F
40007	OARHighAirTemp	8 bit unsigned	1.0	High outdoor air temperature setpoint.	50 – 90 °F
40008	OARLowWaterTemp	8 bit unsigned	1.0	Header/Supply temperature setpoint when outdoor air temperature is at the low outdoor air temperature setpoint (OARLoAirTemp).	70 – 220 °F
40009	OARLowAirTemp	8 bit signed	1.0	Low outdoor air temperature setpoint.	-35 – 40 °F
40010	SetMonth	8 bit unsigned	---	Set real time clock – month (see <i>SetClock</i>)	0 (January) - 11 (December)
40011	SetDay	8 bit unsigned	---	Set real time clock – day (see <i>SetClock</i>)	1 – 31

Figure 40 MODBUS Input/Output Variables (Read/Write)					
Address	Name	Raw Data Type	Scale	Description	Valid Values/Range
40012	SetYear	8 bit unsigned	---	Set real time clock – year (<i>see SetClock</i>)	0 – 99
40013	SetHour	8 bit unsigned	---	Set real time clock – hour (<i>see SetClock</i>)	0 – 23
40014	SetMinute	8 bit unsigned	---	Set real time clock – minute (<i>see SetClock</i>)	0 – 59
40015	SetSecond	8 bit unsigned	---	Set real time clock – second (<i>see SetClock</i>)	0 – 59
40016	SetWeekday	8 bit unsigned	---	Set real time clock – weekday (<i>see SetClock</i>)	1 (Monday) - 7 (Sunday)
40017	SetClock	1 bit unsigned	---	Set (write) the real time clock. Do Not Write more than once per minute To write the real time clock, the system variables (SetMonth, SetMonth, SetDay, SetYear, SetHour, SetMinute, SetSecond, SetWeekday) must first be loaded with the correct date and time. Then, a 1 must be written to the state portion of this system variable to write the new date and time to the system clock.	0 = no action 1 = set/write the clock
40018	DHWSetpoint	16 bit signed	1.0	DHW Setpoint	40 - 200 °F
40019	BMSGPMRate	16 bit unsigned	1.0	GPM rate to be loaded by BMS for calculating how many boilers can run based on flow.	0-1500 GPM
40020	BMSLimitBoilers	16 bit unsigned	1.0	Write the # of boilers that the BMS allows to fire. If x boilers are available, x becomes less than or equal to LimitBoilers.	0-16

Figure 41 MODBUS Input Variables (Read Only)					
Address	Name	Raw Data Type	Scale	Description	Valid Values/Range
30001	BoilersOn	8 bit unsigned	---	The number of boilers currently running.	0 – 16
30002	Modulation	8 bit unsigned	0.01	Current system modulation level.	0 – 100 %
30003	HeaderTemp	16 bit signed	0.01	Header / System temperature.	32 – 250 °F
30004	SupplyTemp	16 bit signed	0.01	Supply temperature.	32 – 250 °F
30005	ReturnTemp	16 bit signed	0.01	Return temperature.	32 – 250 °F
30006	OutsideTemp	16 bit signed	0.01	Outside air temperature.	-40 – 250 °F
30007	Spare1	16 bit signed	---	Raw A/D value from spare 1 input.	-32768 to 32767
30008	Spare2	16 bit signed	---	Raw A/D value from spare 2 input.	-32768 to 32767
30009	Month	8 bit unsigned	---	Real time clock month.	0 (January) - 11 (December)
30010	Day	8 bit unsigned	---	Real time clock day.	1 – 31
30011	Year	8 bit unsigned	---	Real time clock year.	0 – 99
30012	Hour	8 bit unsigned	---	Real time clock hour.	0 – 23
30013	Minute	8 bit unsigned	---	Real time clock minute.	0 – 59
30014	Second	8 bit unsigned	---	Real time clock second.	0 – 59

Figure 41 MODBUS Input Variables (Read Only)					
Address	Name	Raw Data Type	Scale	Description	Valid Values/Range
30015	Weekday	8 bit unsigned	---	Real time clock weekday.	1 (Monday) – 7 (Sunday)
30016	Boiler01Status1	16 bit unsigned	---	Boiler (1 – 16) status flags. These bits indicate the state of the 24VAC interlocks, ignition circuit, and various other conditions. See the values column for a list of conditions. Boiler01 = Master Boiler02 = Member01 ... Boiler16 = Member15	See the “BoilerStatus1” and “BoilerStatus2” Tables below.
30017	Boiler01Status2				
30018	Boiler02Status1				
30019	Boiler02Status2				
30020	Boiler03Status1				
30021	Boiler03Status2				
30022	Boiler04Status1				
30023	Boiler04Status2				
30024	Boiler05Status1				
30025	Boiler05Status2				
30026	Boiler06Status1				
30027	Boiler06Status2				
30028	Boiler07Status1				
30029	Boiler07Status2				
30030	Boiler08Status1				
30031	Boiler08Status2				
30032	Boiler09Status1				
30033	Boiler09Status2				
30034	Boiler10Status1				
30035	Boiler10Status2				
30036	Boiler11Status1				
30037	Boiler11Status2				
30038	Boiler12Status1				
30039	Boiler12Status2				
30040	Boiler13Status1				
30041	Boiler13Status2				
30042	Boiler14Status1				
30043	Boiler14Status2				
30044	Boiler15Status1				
30045	Boiler15Status2				
30046	Boiler16Status1				
30047	Boiler16Status2				
30048	Boiler01RuntimeHigh16	16 bit unsigned	---	Boiler (1 – 16) Runtime seconds High (Upper) and Low (Lower) 16 bit counters. To get the actual runtime for any given boiler (##), the high and low 16 bit counters must be combined (concatenated) into a single 32 bit counter as: Boiler##RuntimeHigh16:Boiler##RuntimeLow16	0 – 4294967295 seconds
30049	Boiler01RuntimeLow16				
30050	Boiler02RuntimeHigh16				
30051	Boiler02RuntimeLow16				
30052	Boiler03RuntimeHigh16				
30053	Boiler03RuntimeLow16				
30054	Boiler04RuntimeHigh16				

Figure 41 MODBUS Input Variables (Read Only)					
Address	Name	Raw Data Type	Scale	Description	Valid Values/Range
30055	Boiler04RuntimeLow16			<p>Example Boiler01Runtime = (Boiler01RuntimeHigh16 * 65536) + Boiler01RuntimeLow16</p> <p>Boiler01 = Master Boiler02 = Member01 ... Boiler16 = Member15</p>	
30056	Boiler05RuntimeHigh16				
30057	Boiler05RuntimeLow16				
30058	Boiler06RuntimeHigh16				
30059	Boiler06RuntimeLow16				
30060	Boiler07RuntimeHigh16				
30061	Boiler07RuntimeLow16				
30062	Boiler08RuntimeHigh16				
30063	Boiler08RuntimeLow16				
30064	Boiler09RuntimeHigh16				
30065	Boiler09RuntimeLow16				
30066	Boiler10RuntimeHigh16				
30067	Boiler10RuntimeLow16				
30068	Boiler11RuntimeHigh16				
30069	Boiler11RuntimeLow16				
30070	Boiler12RuntimeHigh16				
30071	Boiler12RuntimeLow16				
30072	Boiler13RuntimeHigh16				
30073	Boiler13RuntimeLow16				
30074	Boiler14RuntimeHigh16				
30075	Boiler14RuntimeLow16				
30076	Boiler15RuntimeHigh16				
30077	Boiler15RuntimeLow16				
30078	Boiler16RuntimeHigh16				
30079	Boiler16RuntimeLow16				
30080	Boiler01Status3	16 bit unsigned	---	Boiler (1 – 16) stage control input flags. These bits indicate the state of the stage control inputs. See the values column for a list of conditions.	See the “BoilerStatus3” Table below.
30081	Boiler02Status3				
30082	Boiler03Status3				
30083	Boiler04Status3				
30084	Boiler05Status3				
30085	Boiler06Status3				
30086	Boiler07Status3				
30087	Boiler08Status3				
30088	Boiler09Status3				
30089	Boiler10Status3				
30090	Boiler11Status3				
30091	Boiler12Status3				
30092	Boiler13Status3				
30093	Boiler14Status3				
30094	Boiler15Status3				

Figure 41 MODBUS Input Variables (Read Only)					
Address	Name	Raw Data Type	Scale	Description	Valid Values/Range
30095	Boiler16Status3				
----- The following registers are available starting in firmware version 2.0 -----					
30096	Boiler01SupplyTemp	16 bit signed	0.01	Boiler (1 – 16) supply temperature (if available). See BoilerStatus2 to determine if the sensor is present. Boiler01 = Master Boiler02 = Member01 ... Boiler16 = Member15	32 – 250 °F
30097	Boiler02SupplyTemp				
30098	Boiler03SupplyTemp				
30099	Boiler04SupplyTemp				
30100	Boiler05SupplyTemp				
30101	Boiler06SupplyTemp				
30102	Boiler07SupplyTemp				
30103	Boiler08SupplyTemp				
30104	Boiler09SupplyTemp				
30105	Boiler10SupplyTemp				
30106	Boiler11SupplyTemp				
30107	Boiler12SupplyTemp				
30108	Boiler13SupplyTemp				
30109	Boiler14SupplyTemp				
30110	Boiler15SupplyTemp				
30111	Boiler16SupplyTemp				
30112	Boiler01ReturnTemp	16 bit signed	0.01	Boiler (1 – 16) return temperature (if available). See BoilerStatus2 to determine if the sensor is present. Boiler01 = Master Boiler02 = Member01 ... Boiler16 = Member15	32 – 250 °F
30113	Boiler02ReturnTemp				
30114	Boiler03ReturnTemp				
30115	Boiler04ReturnTemp				
30116	Boiler05ReturnTemp				
30117	Boiler06ReturnTemp				
30118	Boiler07ReturnTemp				
30119	Boiler08ReturnTemp				
30120	Boiler09ReturnTemp				
30121	Boiler10ReturnTemp				
30122	Boiler11ReturnTemp				
30123	Boiler12ReturnTemp				
30124	Boiler13ReturnTemp				
30125	Boiler14ReturnTemp				
30126	Boiler15ReturnTemp				
30127	Boiler16ReturnTemp				
30128	Boiler01CyclesHigh16	16 bit unsigned	---	Boiler (1 – 16) Cycles High (Upper) and Low (Lower) 16 bit counters. To get the actual cycle count for any given boiler (##), the high and low 16 bit counters must be combined (concatenated) into a single 32 bit counter as:	0 – 4294967295
30129	Boiler01CyclesLow16				
30130	Boiler02CyclesHigh16				
30131	Boiler02CyclesLow16				
30132	Boiler03CyclesHigh16				
30133	Boiler03CyclesLow16				

Figure 41 MODBUS Input Variables (Read Only)					
Address	Name	Raw Data Type	Scale	Description	Valid Values/Range
30134	Boiler04CyclesHigh16			Boiler##CyclesHigh16:Boiler##CyclesLow16 Example Boiler01Cycles = (Boiler01CyclesHigh16 * 65536) + Boiler01CyclesLow16 Boiler01 = Master Boiler02 = Member01 ... Boiler16 = Member15	
30135	Boiler04CyclesLow16				
30136	Boiler05CyclesHigh16				
30137	Boiler05CyclesLow16				
30138	Boiler06CyclesHigh16				
30139	Boiler06CyclesLow16				
30140	Boiler07CyclesHigh16				
30141	Boiler07CyclesLow16				
30142	Boiler08CyclesHigh16				
30143	Boiler08CyclesLow16				
30144	Boiler09CyclesHigh16				
30145	Boiler09CyclesLow16				
30146	Boiler10CyclesHigh16				
30147	Boiler10CyclesLow16				
30148	Boiler11CyclesHigh16				
30149	Boiler11CyclesLow16				
30150	Boiler12CyclesHigh16				
30151	Boiler12CyclesLow16				
30152	Boiler13CyclesHigh16				
30153	Boiler13CyclesLow16				
30154	Boiler14CyclesHigh16				
30155	Boiler14CyclesLow16				
30156	Boiler15CyclesHigh16				
30157	Boiler15CyclesLow16				
30158	Boiler16CyclesHigh16				
30159	Boiler16CyclesLow16				
30160	Boiler01Status4	16 bit unsigned	---	Boiler (1 – 16) status4 flags. These bits indicate the state of various boiler statuses. Boiler01 = Master or “Connected Boiler” Boiler02 = Member01 ... Boiler16 = Member15	See the BoilerStatus4 Flags in Appendix A.
30161	Boiler02Status4				
30162	Boiler03Status4				
30163	Boiler04Status4				
30164	Boiler05Status4				
30165	Boiler06Status4				
30166	Boiler07Status4				
30167	Boiler08Status4				
30168	Boiler09Status4				
30169	Boiler10Status4				
30170	Boiler11Status4				
30171	Boiler12Status4				
30172	Boiler13Status4				
30173	Boiler14Status4				

Figure 41 MODBUS Input Variables (Read Only)					
Address	Name	Raw Data Type	Scale	Description	Valid Values/Range
30174	Boiler15Status4				
30175	Boiler16Status4				
30176 ... 30207	RESERVED	---	---	---	---
30208	Boiler01DHWTemp	16 bit signed	---	Boiler (1 – 16) DHW temperature (if available). See BoilerStatus4 to	32 – 250 °F
30209	Boiler02DHWTemp				
30210	Boiler03DHWTemp				
30211	Boiler04DHWTemp				
30212	Boiler05DHWTemp				
30213	Boiler06DHWTemp				
30214	Boiler07DHWTemp				
30215	Boiler08DHWTemp				
30216	Boiler09DHWTemp				
30217	Boiler10DHWTemp				
30218	Boiler11DHWTemp				
30219	Boiler12DHWTemp				
30220	Boiler13DHWTemp				
30221	Boiler14DHWTemp				
30222	Boiler15DHWTemp				
30223	Boiler16DHWTemp				
30224	Boiler01Modulation	16 bit signed	---	The running (“display”) modulation. This is typically the actual running modulation except under special circumstances when the boiler is running in a self-protection mode (Op. Limit, ½ Fire Rate, etc.) Boiler01 = Master or “Connected Boiler” Boiler02 = Member01 ... Boiler16 = Member15	0 - 100
30225	Boiler02Modulation				
30226	Boiler03Modulation				
30227	Boiler04Modulation				
30228	Boiler05Modulation				
30229	Boiler06Modulation				
30230	Boiler07Modulation				
30231	Boiler08Modulation				
30232	Boiler09Modulation				
30233	Boiler10Modulation				
30234	Boiler11Modulation				
30235	Boiler12Modulation				
30236	Boiler13Modulation				
30237	Boiler14Modulation				
30238	Boiler15Modulation				
30239	Boiler16Modulation				
30240	OperatingSetpoint	16 bit signed	---	This is the current operating or active setpoint. It may be: 1) The normal heating setpoint. 2) The DHW setpoint if running in DHW mode.	40 - 220 °F

Figure 41 MODBUS Input Variables (Read Only)					
Address	Name	Raw Data Type	Scale	Description	Valid Values/Range
				3) A calculated setpoint if running in Outdoor Air Reset Mode 4) The 4-20ma (0-10V) setpoint.	
30241	AvailableBoilers	16 bit signed	---	The maximum number of boilers available to fire.	0 - 16
30242	BTUHigh16	32 bit unsigned			
30243	BTULow16				
30247	SystemReturnTemp	16 bit signed	---	The system return temperature (if available). See BoilerStatus4 to determine if the sensor is present.	32 – 250 °F
30265	SystemFlowHigh16	32 bit unsigned	0.01	Boiler SystemFlow High (Upper) and Low (Lower) 16 bit registers. To get Boiler SystemFlow High (Upper) and Low (Lower) 16 bit registers. To get the actual SystemFlow, the high and low 16 bit registers must be combined (concatenated) into a single 32 bit counter as: SystemFlowHigh16: SystemFlowLow16 Example SystemFlow = ((SystemFlowHigh16 * 65536) + SystemFlowLow16) * 0.01 This value is either the system flow meter reading or the value written to the BMSFlowRateGPM register by the BMS.	0-1500 GPM
30266	SystemFlowLow16				
30269	HeatingBoilersOn	8 bit unsigned	---	The number of boilers currently running for heating.	0 – 16
30270	DHWBoilersOn	8 bit unsigned	---	The number of boilers currently running for DHW.	0 – 16
30271	ManualBoilersOn	8 bit unsigned	---	The number of boilers currently running due to a local override, T1, T2, AA/High Fire, etc.	0 – 16

Figure 42 MODBUS — BoilerStatus1 Flags		
Bit	Description	Valid Values/Range
0	Pilot Valve	0 = closed, 1 = open
1	Blower Running	0 = off, 1 = running
2	Ignition Alarm	0 = ok, 1 = alarm
3	Valve Alarm	0 = ok, 1 = alarm
4	High Limit	0 = ok, 1 = tripped
5	Air Prove Switch	0 = open, 1 = closed
6	RESERVED (FACTORY)	
7	Software Operator	0 = off, 1 = on
8	Header Sensor not Detected	0 = detected, 1 = not detected
9	Supply Sensor not Detected	0 = detected, 1 = not detected

Figure 42 MODBUS — BoilerStatus1 Flags		
Bit	Description	Valid Values/Range
10	Return Sensor not Detected	0 = detected, 1 = not detected
11	Outside Sensor not Detected	0 = detected, 1 = not detected
12	System Pump	0 = off, 1 = on
13	Combustion Air Damper Obsolete –Available only on v1.x controls	0 = off, 1 = on
14	Master Boiler	0 = member, 1 = master
15	Boiler Detected (at this address)	0 = not detected, 1 = detected

Figure 43 MODBUS — BoilerStatus2 Flags		
Bit	Description	Valid Values/Range
0	Disabled – boiler is offline For instance: Minimum off Time, Flow, Local Override, Calibrate etc	0 = enabled, 1 = disabled
1	Heat Demand	0 = no demand, 1 = demand (1)
2	Alarm An alarm or warning condition has occurred. An attempt(s) will automatically be made to recover and resume normal operation.	0 = ok, 1 = alarm
3	Failed A condition has occurred under which the boiler can no longer run.	0 = ok, 1 = failed
4	Member Error An “Alarm” or “Failed” condition has occurred on one (or more) of the member boilers.	0 = ok, 1 = error
5	Boiler Running Main Valve is open and Modulation Delay time has expired	0 = off, 1 = running
6	Pump Running	0 = off, 1 = running
7	Spare 3 Interlock	0 = open, 1 = closed
8	LWCO Interlock (Low Water Cut Off)	0 = open, 1 = closed
9	VFD Interlock (Variable Frequency Drive)	0 = open, 1 = closed
10	Gas Prove Interlock	0 = open, 1 = closed
11	Spare 4 Interlock	0 = open, 1 = closed
12	Operator Interlock	0 = open, 1 = closed
13	Water Prove (Flow) Interlock	0 = open, 1 = closed
14	UV Sensor Air Prove Interlock	0 = open, 1 = closed
15	Main Valve	0 = closed, 1 = open

This BoilerStatus2 Heat Demand Flag is a combination of the Heat Demand input and the Modbus Heat Demand (40001).

Figure 44 MODBUS — BoilerStatus3 Flags		
Bit	Bit	Bit
0	AA High Fire	0 = off, 1 = on
1	Heat Demand (Local Override)	0 = off, 1 = on (1)
2	4-20ma Remote Enable	0 = off, 1 = on
3	Outdoor Air Reset Override	0 = off, 1 = on
4	T1	0 = off, 1 = on
5	T2	0 = off, 1 = on
6	Obsolete	0 = off, 1 = on
7	Obsolete	0 = off, 1 = on
8	reserved for future use	---
9	reserved for future use	---
10	reserved for future use	---
11	reserved for future use	---
12	reserved for future use	---
13	reserved for future use	---
14	reserved for future use	---
15	reserved for future use	---

This BoilerStatus3 Heat Demand Flag is Heat Demand input. On member boilers, this indicates a “Local Override”.

BoilerStatus4 Flags

Bit	Description	Valid Values/Range
0	DHW Enabled (1) DHW Mode had been enabled in the menus.	0 = off, 1 = on (menu)
1	Combustion Air Damper Prove (1) Status of Combustion Air Damper Prove Input J12B	0 = not proven, 1 = proven
2	Call Service Fault	0 = off, 1 = on
3	Air Switch (Blower) Fault	0 = off, 1 = on
4	---	---
5	---	---
6	---	---
7	---	---
8	---	---
9	DHW Sensor not detected (1)	0 = detected, 1 = not detected
10	DHW Boiler (1) This control board has been designated a DHW boiler by cutting the DHW jumper (JPS1).	0 = no, 1 = yes (DHW jumper cut)
11	Operating Limit Clamp (1) Boiler input is being limited (clamped) due to a high supply (outlet) temperature.	0 = off, 1 = clamped
12	Firing boilers limited by value in BMS Flow Rate Register (1)	0 = not limited, 1 = limited
13	Firing boilers limited by value in BMS Limit Boilers Register (1)	0 = not limited, 1 = limited
14	Stack Sensor not detected (2)	0 = detected, 1 = not detected
15	System Return Sensor not detected (2)	0 = detected, 1 = not detected

(1) Available in firmware version 1.30+.

(2) Available in firmware version 2.00+.

Troubleshooting

This section is included as an aide to help troubleshoot problems with the setup and operation of the boiler. See *Appendix A* for additional fault messages.

Situation:

Nothing happens when the power switch is turned on.

1. If the Ignition Control is active, but the front panel display is inactive check:
 - a. Cable and cable polarity from the control board to the display.
 - b. J14 on control board. The transformer supplies 24vac to power the control.
 - c. Check for 120vac on the primary of the transformer and 24vac on the secondary. If one of the 24vac interlocks has been shorted to ground or the 24vac output is low, the transformer may be damaged or a 24vac circuit may be miss-wired.

NOTICE

The H-Net control is equipped with resettable fuses on the power input circuit. Wiring power incorrectly to the unit will cause these fuses to open. Once the incorrect wiring is corrected, the fuses should reset themselves in less than 5 minutes.

Situation:

You get the error message for the Combustion Air Damper.

1. The prove switch for the combustion air damper is not closing. Check to make sure the dampers are being controlled by the output relay. Also check to make sure the prove switch is wired and working properly.
2. If (1.) has been done and you are using SPARE 1 and you continue to get the error message, check the sensor TYPE specified for sensor #5 in the sensors menu. If it is set to NONE the controller will not recognize the closed circuit. Set the Sensor #5 to ON/OFF.
3. If you are not using the combustion air damper then it needs to be disabled in the AUX FUNCTIONS menu.

Situation:

The display is displaying random characters or the control keeps resetting.

There may exist a grounding problem with the controller or one of the boilers, pumps, contactors or other devices connected to it. If all grounding is correct, there may be an issue with radiated or induced electrical noise (interference). This may be caused by, arcing across a contactor's contacts when starting a pump motor, or a large electrical load. It may also be caused by, the ignition transformer being improperly grounded, or the spark gap set incorrectly.

1. Attempt to identify the noise source:
2. What is the boiler/controller trying to do at the time of the failure?
3. Is the boiler on the same circuit as the noise source? (the boiler should have isolated power.)
4. Are shielded sensor wires used? (Ensure the shields are grounded only at the boiler control end.)
5. Are any sensors or sensor wires located near a transmitting antenna? (Move sensor)

Situation:

There are no heating boilers on.

1. Check the settings for WWS SETPOINT, WARM WEATHER SHUTDOWN; if the outdoor air temperature is above the WWS SETPOINT and WARM WEATHER SHUTDOWN is set to YES, the circulator pump relay will be locked out and the heating boilers will not fire.
2. If the water temperature is within the heating band around the setpoint, boilers will not come on. The water temperature must fall below the lower band limit to begin firing boilers.

Situation:

Unable to change the # of Boilers in the BOILERS menu.

1. In H-Net method, the KN-Series control auto-detects the boilers in the system and adjusts the # of boilers accordingly.
2. Using H-NET, if the # of Boilers is not being adjusted properly to the actual amount of boilers in the system, check each boiler. There can only be (1) master boiler, but there can be up to 15 member boilers. Currently, a total of 16 boilers in a system.

Situation:

The boilers menu only indicates 1 boiler, but there are member boilers connected and the amber light blinks on all of the boilers communication's jacks.

1. Ensure that the latest version of firmware is installed on all boilers. All boilers in a system must have the same firmware revision.
2. Ensure the proper termination is set on the Master and the last Member boiler.

Situation:

You get the error message – WATER FLOW SWITCH or WAITING FOR FLOW.

1. If the control does not sense a closed circuit at input connection, WTR FLW. Check to make sure the circuit for the circulator pump is correct, that the pump is being energized, and that the flow prove switch is working properly.
2. If there is no flow prove switch, check to make sure that a jumper wire has been hooked up to J11B, WTR FLW interlock.

Situation:

H-Net boilers are detected but then lost and then detected again etc...

1. The H-Net communications cable may be receiving interference from the blower, ignition, or other form of radiated electrical noise. Termination of the jumpers may not be correct or there is more than one master.
 - a. Ensure that the termination jumpers are set on the MASTER boiler and only the LAST MEMBER boiler. All of the other member boilers should have their termination jumpers in the non-terminated position.
 - b. There may be (2) or more MASTER boilers. Ensure that only one header sensor is present and connected to the SYS/DHW input. There should be no wires or sensors connected to the SYS/DHW input if the boiler is operating as a member. This input is auto detected and defines the boiler as a MASTER.
 - c. Ensure the cable to connect the H-Net is of a shielded or twisted pair type. Shielding of the cable is required.

- d. Minimize the electrical interference by routing the communications cable away from electrical noise sources, such as: Motors, ignition controls, contactors etc...

Situation:

Only the MASTER boiler Fires, but the system has many boilers and is using H-Net.

1. In order for the MASTER boiler to act as a MASTER, the header sensor must be set to TYPEZ, and there must be a header sensor present. At power-up, the header sensor is auto detected. If the temperature of the header sensor at power-up is greater than –25 F and less than 240 F it is considered a valid sensor. The boiler will default to the MEMBER mode if the temperature is not in this range and can only be run locally or by external inputs.
 - a. If the LOAD FACTORY DEFAULTS has been used to restore all the default settings, the header sensor has been set to NONE. This needs to be set as stated in 1, and the header sensor will need to be replaced or the temperature brought into a valid range. A power cycle of the boiler will detect the sensor if it is in the range as stated in 1.).
 - b. The H-Net needs a communications cable daisy-chained between boilers. Ensure that a good connection is made on the communications board and that the lights on the dual RJ45 jack flash (roughly twice a second). The MASTER is the only one that should flash with no communications cables plugged in.

Situation:

I am in CALIBRATE and I cannot fire the boiler to adjust it.

1. Only one, but any one of the T1-T2 inputs can be used to start the boiler. All other inputs are disabled. This method prevents an external control or Building Management System from trying to control the boiler while it is offline and being calibrated. If the boiler is being used as a staged boiler controlled by an external control, the staged inputs need to be disconnected before CALIBRATION, since more than one of the T inputs may be closed by the external control.

Situation:**You have forgotten the password.**

- As a last resort, you can turn the controller off, then depress and hold the ESC key while turning it back on. This will load the default password "AAAAAA".

Situation:**Firmware update program starts to load, but then stops, or does not load at all.**

- Check that the termination shunts J3 and J6 are not in the termination setting. If they are, remove them temporarily while updating. Restore them for proper communication with a building management system.
- Ensure that the USB driver for your PC/Laptop computer is properly installed.
- Disconnect BMS or Processor Module if connected.

Situation:**All HeatNet Boilers fire at the same time.**

- This is usually caused by the HeatNet addresses on the Member boilers not being set. If the address on each boiler is not set, then all boilers will have address = 2 by default. When the Master boiler calls to fire boiler #2, all boilers with address #2 will fire. Set each Member boiler to a unique address from 2-16.
- Check the ADD Boiler delay time to ensure it is at a reasonable value. A setting of 0 will start all the boilers at the same time.

Situation:**The boiler is showing that it is running at 45% and there is no fire in the sight glass.**

- The Boiler always shows it's called for firing modulation %. This is not an indication of what the boiler is actually firing at. If the ignition control fails to receive a call to fire (last interlock closed on terminal 6 of the ignition control) the display will indicate the called for %. Check if the ignition control is in standby, if so then the HeatNet control has closed the Start contact on J5.10 (Limits) and is waiting for the Blower relay to close on the ignition control which is monitored on J5.3 of the HeatNet control.

Situation:**I can hear the blower ramping up and down and****the firing rate is changing, but the display indicates it is running at the same modulation rate.**

- The Boiler always shows it's called for firing modulation %. This is not an indication of what the boiler is actually firing at. In this case, the boiler is trying to meet the called for modulation % which is displayed, but is unable to do so. The boiler protects itself by looking at it's supply water temperature and the temperature is probably in the Operating Limit Band. While in the operating limit band, the HeatNet control limits the input of the boiler. The boiler tries to deliver the most input it can in an attempt to meet the called for modulation % without tripping the operating limit.
- If the boiler is constantly varying in blower speed and in the operating limit band there may be not enough flow through the boiler or the Operating Limit/Operating Limit Band may be improperly set. The Operating Limit/Operating Limit Band should not overlap the heating band. This may occur when a building management system is controlling the setpoint and is setting the setpoint in the operating limit band.
- Example: Setpoint set to 180F (by Building Management) and the Operating Limit is set to 200F with a 20F Operating Limit Band. When the boiler is trying to deliver 180F to the load it's supply temperature would be a minimum of 180F. The beginning of the Operating Limit Band (looks at supply temp) would be 200F-20F = 180F. Now, when the Master is trying to maintain setpoint at 180F, the boiler is trying to reduce input beginning at 180F at its supply sensor and as a result, fighting the setpoint. The Operating Limit band needs to be reduced in this case, while taking into account the Heat Band differential.

Situation:**The Master boiler sees all of the Member boilers in the system, but does not fire any of the Members.**

- If the Master modulates to 100% without firing a Member boiler and the Member boilers are seen by the Master (in menu SETUP:BOILERS), then the Member boilers are sending back offline status to the Master.
 - The Member boilers may have an alarm or error condition which would be indicated by a blinking boiler # in the Boilers Firing screen.
 - Ensure the HeatNet is set up properly: Amber lights blink on HeatNet Jacks. Only one Master boiler.

- c. If the Member boiler is in Local Mode then it also would not be called and report unavailable to the Master.
- d. If the Local flow switch for the Local pump is wired to the System flow switch input this would also create an offline condition. The Member needs to detect system flow or have a jumper across that sensor input in order for the Member boiler to report available status. The Local flow prove switch must be wired to the Water Flow interlock sensor input.

Situation:

We are using a BACnet or LonWorks bridge. We can talk to the bridge, but all of the data is zero (0) or invalid.

This condition usually indicates that the bridge is not communicating with the HeatNet control. When operating properly, the bridge continuously reads data from the boiler on the Modbus port into an internal buffer. When a BACnet or LonWorks read request is received, the buffered values are placed in a BACnet or LonWorks packet and sent. If the bridge has never been able to successfully read data from the control, all data points will have their default value which is typically zero. In this situation, the control will also not respond to write commands; for instance changing the setpoint.

1. The control's **MODBUS ADDRESS** must be set to one (1). This is set in the **ADVANCED SETUP->DISTRIBUTED CONTROL** menu. On older (legacy) firmware this setting was also called the **CONSOLE ADDRESS**.
2. The control's **BAUD** (rate) must be set to 19200 and the **DATA FORMAT** must be set to **8E1** (8 data bits, even parity, 1 stop bit). On older (legacy) versions of firmware, the **DATA FORMAT** was called **PARITY** which must be set to **EVEN**. These settings are set in the **ADVANCED SETUP->COMMUNICATIONS** menu.
3. Check the termination on the BMS/Modbus port. If the control is the first or last device on the Modbus RTU network, it should be terminated. For the short cable runs (for instance when using a BACnet or LonWorks bridge on a Revision 1.x board), the termination should be in, but usually doesn't matter.
4. Check the wiring. The Modbus RTU (RS485) connections on the HeatNet control are A(+), B(-), and G (ground). Some systems use opposite polarity; A(-), B(+). Always use the polarity to determine the proper connections. **A ground wire must always be used**

and a shielded twisted wire is STRONGLY suggested.

5. The HeatNet LonWorks and BACnet bridges plug directly into Revision 2.x+ boards. Legacy boards (Revision 1.x) required a ProtoCarrier to provide power and the RS485 signal conversion to the bridge. The RS485 signal conversion chips are easily damaged by electrical noise, ground loops, and large differences in ground potential between devices on the network. This is a common problem faced by all RS485 devices, not just the HeatNet control. To help eliminate grounding problems, nylon standoffs are required to isolate the bridge from the boiler chassis. The ProtoCarrier should also be powered from the 24VDC output on the HeatNet control to help eliminate electrical noise (VFD and spark pickup, power spikes, etc.) on the power supply lines. Please download complete HeatNet bridge installation instructions from the product web site.
 - a. When the ProtoCarrier is functional, the small green surface mount TX and RX LEDs near the 6-pin connector (power and communications) should be flashing regularly.
 - b. If the TX LED flashes very briefly about once per minute, the ProtoCarrier has most likely been damaged, please contact Tech Services.
 - c. If either LED is always on, the ProtoCarrier has most likely been damaged, please contact Tech Services.

Situation:

We are using a Building Management System (BMS) to control the boilers. We can write the setpoints, but they keep changing back to their "default" values after approximately 60 seconds.

1. When using a BMS, the setpoint values work in conjunction with the **SETPOINT TIMER**. The **SETPOINT TIMER** is a failsafe feature used to help detect that a BMS is no longer working or communicating with the control. The time must be regularly loaded with a predetermined number of seconds (1 – 65535). Every second this value will decremented. If it reaches zero, the local (permanently saved) values for the setpoints will be loaded. The concept is that periodically (or every time a setpoint is written), the BMS must write this value. If the value reaches zero (0), the HeatNet control assumes that the BMS is no longer functional and "safe" operational values for the setpoints will be restored. As an example, if it is decided that the BMS will write the control every 5 minutes, you may decide to write 600

- seconds (10 minutes) to the setpoint timer. If after 10 minutes (5 minutes longer than the normal write interval) the BMS has not written the timer, the saved setpoint values will be restored.
2. As a convenience, the **SETPOINT TIMER** is automatically loaded with 60 seconds (if it has fallen below 60) each time the setpoint is written. If you decide to take advantage of this convenience, you would need to write the setpoint periodically at less than 1 minute intervals.
 3. Newer firmware versions allow the **SETPOINT TIMER** failsafe feature to be disabled by writing a zero (0) to the timer. The feature will automatically revert back to the enabled state whenever the control is reset or power cycled. The **SETPOINT TIMER** failsafe feature can permanently disabled (or enabled) in firmware versions **3.35** or greater. This setting can be changed in the **ADVANCED SETUP->COMMUNICATIONS** menu.

KN HeatNet Control Run Screen

Hold the BACK button down for 5 seconds to enter the SETUP menus

Press the UP or DOWN Arrow Keys to navigate the display screen.

If the Header Sensor is present the menu will display **SYSTEM SET**, otherwise it will display **LOCAL SET**.

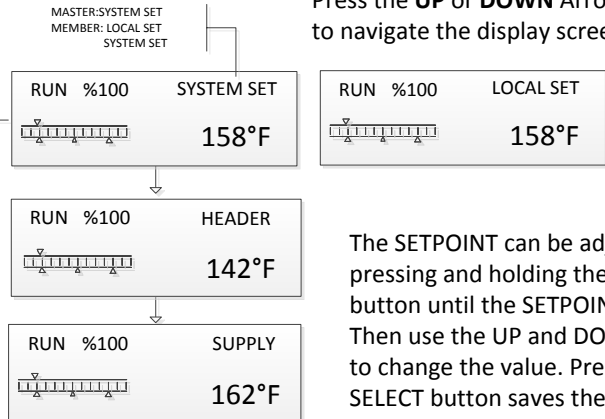

The SETPOINT can be adjusted by pressing and holding the SELECT button until the SETPOINT flashes. Then use the UP and DOWN buttons to change the value. Pressing the SELECT button saves the value.

CALIBRATE

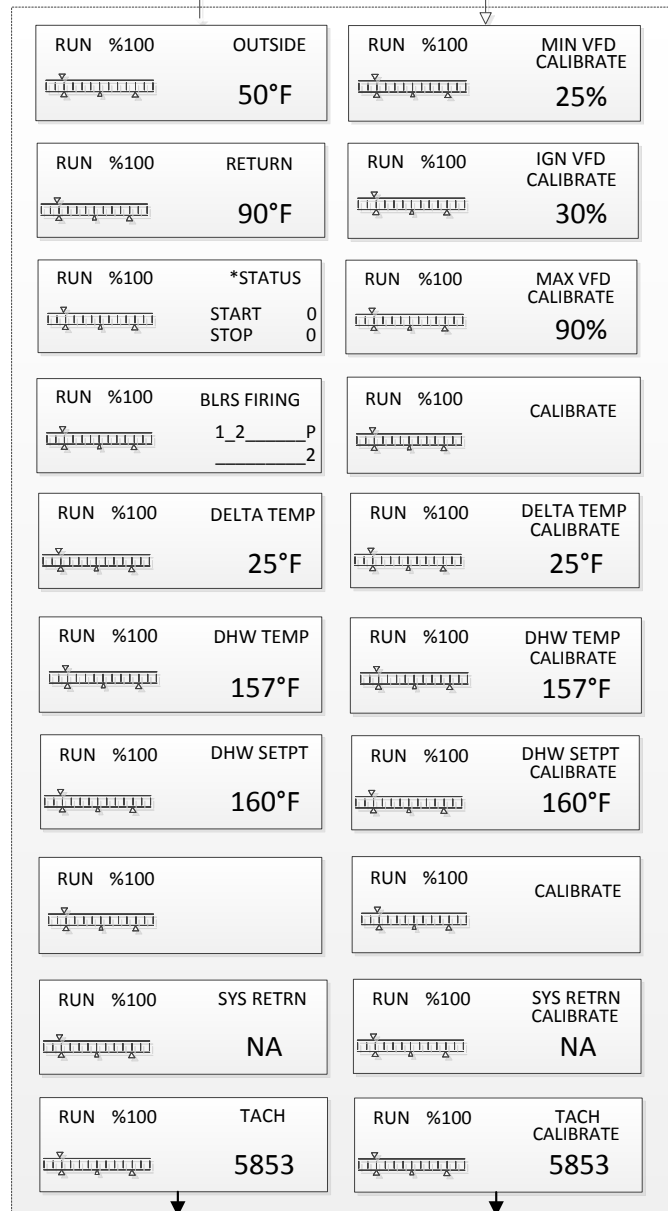

The BLRS FIRING screen is used by the Master boiler to indicate which boilers are firing. If the boiler # is blinking a problem exists on that boiler. If a symbol is displayed, that positions boiler was detected. If a 'D' is displayed, the Master is controlling that boiler as a DHW boiler. To the far right the current active system pump is displayed vertically as P1 or P2 (Pump 1 or Pump 2)

KN HeatNet Control Run Screen - Continued

DHW screens are available depending on the DHW mode of operation.

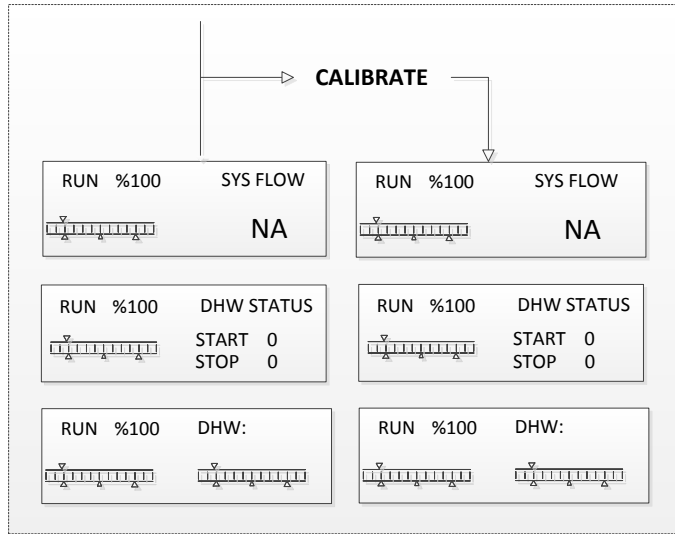

KN HeatNet V3 Menu Tree — ADVANCED THERMAL HYDRONICS

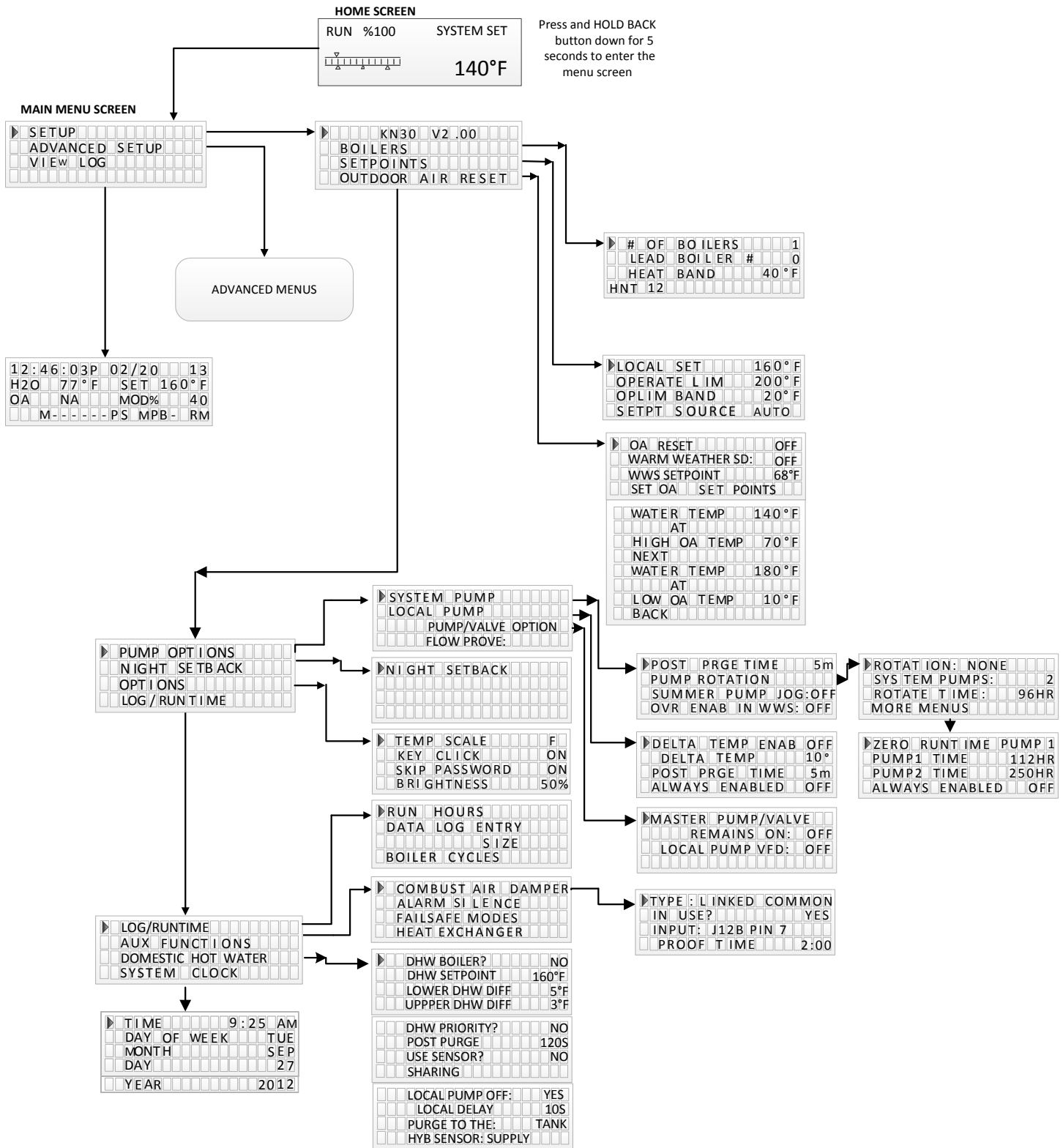

KN HeatNet V3 Advanced Menu Tree – ATH

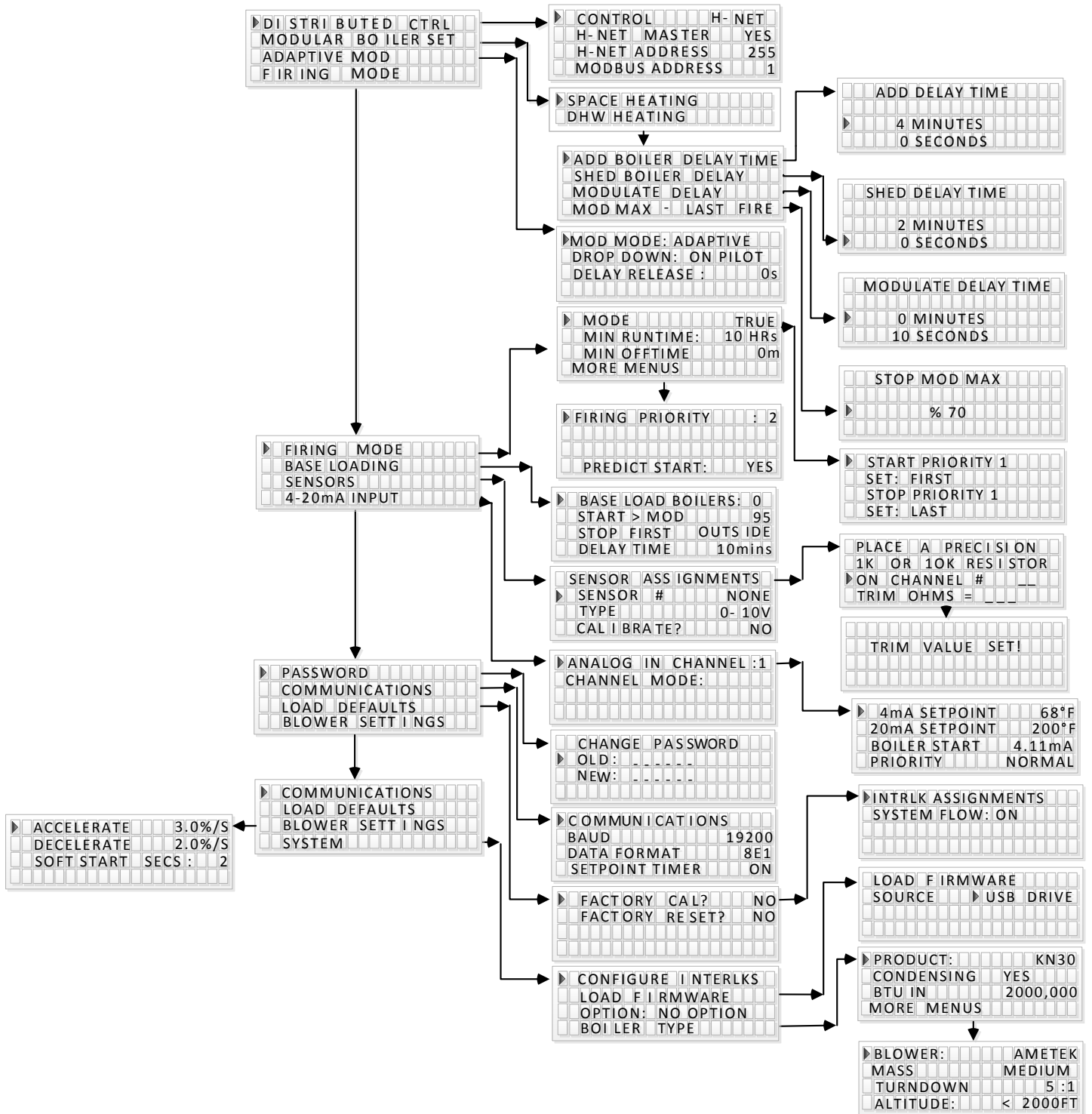

Worksheet

SETUP MENU				
BOILERS				
# of BOILERS				
LEAD STAGE				
HEAT BAND	°			
SETPOINTS				
SYSTEM/LOCAL SETPOINT	°			
OPERATE LIMIT	°			
OP LIM BAND	°			
SETPOINT SOURCE				
OUTDOOR AIR RESET	°			
OA RESET				
WARM WEATHER SD				
WWS SETPOINT	°			
SET OA SETPOINTS				
WATER TEMP	°			
@				
HIGH OA TEMP	°			
WATER TEMP	°			
@				
LOW OA TEMP	°			
PUMP OPTIONS				
SYSTEM PUMP				
POST PURGE TIME				
PUMP ROTATION				
ROTATION:				
SYSTEM PUMPS:				
ROTATE TIME:				
MORE MENUS				
ZERO RUNTIME PUMP				
PUMP1 TIME				
PUMP2 TIME				
ALWAYS ENABLED				
SUMMER PUMP JOG				
OVR ENAB IN WWS				
LOCAL PUMP				
DELTA TEMP ENAB				
DELTA TEMP	°			
POST PRGE TIME	s			
ALWAYS ENABLED				
PUMP/VALVE OPTION				

REMAINS ON:				
LOCAL PUMP VFD				
FLOW PROVE				
NIGHT SETBACK				
SETBACK ENTRY	1	2	3	4
ENTRY IS				
SETBACK	°	°	°	°
SETBACK TIME				
START DAY				
TIME				
END DAY				
TIME				
OPTIONS				
TEMP SCALE	°			
KEY CLICK				
SKIP PASSWORD				
BRIGHTNESS	%			
LOG/ RUNTIME				
RUN HOURS				
DATA LOG ENTRY				
SIZE				
BOILER CYCLES				
AUX FUNCTIONS				
COMBUST AIR DAMPER				
TYPE:				
IN USE?				
INPUT:				
PROOF TIME				
ALARM SILENCE SWITCH				
IN USE				
INPUT:				
FAILSAFE MODES				
H-NET COMM LOST				
LOW TEMP:				
TEMP <				
HEAT EXCHANGER				
EXCHGR DELTA T				
LIMIT-> HALF RATE				
DOMESTIC HOT WATER				
DHW BOILER?				
DHW SETPOINT				
LOWER DHW DIFF				
UPPER DHW DIFF				

DHW PRIORITY?				
POST PURGE				
USE SENSOR?				
SHARING				
LOCAL PUMP OFF				
LOCAL DELAY				
PURGE TO THE				
HYB SENSOR:				
SYSTEM CLOCK				

ADVANCED SETUP				
DISTRIBUTED CTRL				
CONTROL				
MASTER TYPE				
H-NET ADDRESS				
MODBUS ADDRESS				
MODULAR BOILER SET				
SPACE HEATING				
ADD BOILER DELAY				
SHED BOILER DELAY				
MODULATE DELAY TIME				
MOD MAX – LAST FIRE		%		
DHW HEATING				
ADD BOILER DELAY				
SHED BOILER DELAY				
MODULATE DELAY TIME				
MOD MAX – LAST FIRE		%		
ADD BOILER DELAY				
SHED BOILER DELAY				
MODULATE DELAY TIME				
MOD MAX – LAST FIRE		%		
ADAPTIVE MOD				
MOD MODE:				
DROP DOWN				
DELAY RELEASE				
FIRING MODE				
MODE				
MIXED START PRIORITY 1				
SET:				
STOP PRIORITY 1				
SET:				
MIN RUNTIME				
MIN OFF TIME				

FIRING PRIORITY								
PREDICT START								
BASE LOADING								
BASE LOAD BOILERS:								
START > MOD								
STOP								
DELAY TIME								
SENSORS								
SENSOR #	OUTSIDE	SUPPLY	R E T U R N	H E A D E R	DHW	6	7	8
TYPE								
4-20mA INPUT								
ANALOG IN CHANNEL:								
CHANNEL MODE:								
4mA SETPOINT								
20mA SETPOINT								
BOILER START								
PRIORITY								
PASSWORD								
COMMUNICATIONS								
BAUD								
DATA FORMAT								
SETPOINT TIMER								
SETPOINT TIME								
FLOWMETER								
FLOWMETER								
GLYCOL MIX								
INPUT TYPE								
LOWEST FLOW								
HIGHEST FLOW								
FULL SCALE								
FLOW FACTOR								
BLOWER SETTINGS (AMETEK BLOWER)								
ACCELERATE								
DECELERATE								
SOFT START SECS:								
OFF BOILER-BLOWR%								
SYSTEM								
CONFIGURE INTERLKS								
INTRLK ASSIGNMENTS								
SYSTEM FLOW... ON								
LOAD FIRMWARE	Version:							
OPTION:								

BOILER TYPE				
PRODUCT				
CONDENSING				
BTU IN				
BLOWER				
MASS				
TURNDOWN				
ALTITUDE				

CALIBRATION SETTINGS

MIN VFD	
IGN VFD	
MAX VFD	

Type II Thermistor Resistance/Temperature Table

Temp °C	Temp °F	Resistance	Temp °C	Temp °F	Resistance
-40	-40	336,450	60	140	2,488
-35	-31	242,660	65	149	2,083
-30	-22	176,960	70	158	1,752
-25	-13	130,410	75	167	1,479
-20	-4	97,072	80	176	1,255
-15	5	72,951	85	185	1,070
-10	14	55,326	90	194	915.4
-5	23	43,326	95	203	786.6
0	32	32,650	100	212	678.6
5	41	25,391	105	221	587.6
10	50	19,899	110	230	510.6
15	59	15,711	115	239	445.2
20	68	12,492	120	248	389.6
25	77	10,000	125	257	341.9
30	86	8,057	130	266	301.0
35	95	6,531	135	275	265.8
40	104	5,326	140	284	235.4
45	113	4,368	145	293	209.0
50	122	3,602	150	302	186.1
55	131	2,986			

* Status Information



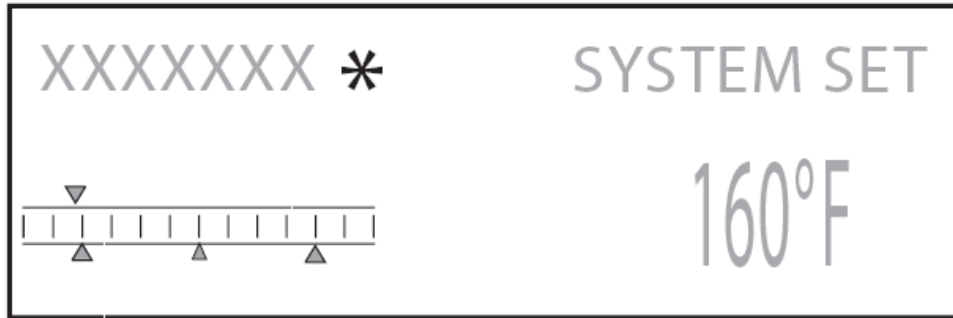

Whenever an * is displayed on the RUN screen it indicates that there is more information available about the current running conditions. This information can be viewed by going to the *STATUS screen as shown on the previous page. For more information on the parameters discussed here please see the Default Settings & Menu Item Descriptions — SETUP, starting on page 61.



Status information screens

<p>The screenshot shows the same control panel interface as above. The text 'SYSTEM SET' and '160°F' are replaced by '*STATUS op limit' and 'START XX' and 'STOP XX' respectively. The status indicator * is present.</p>	<p>This screen indicates that the boiler's SUPPLY Temperature has gone above the OPERATOR LIMIT. This will mainly be seen on member boilers to show why they are not available to fire.</p>
<p>The screenshot shows the same control panel interface as above. The text 'SYSTEM SET' and '160°F' are replaced by '*STATUS limit clamp' and 'START XX' and 'STOP XX' respectively. The status indicator * is present.</p>	<p>This screen indicates that the boiler's SUPPLY temperature has risen inside the OPERATOR LIMIT BAND.</p>
<p>The screenshot shows the same control panel interface as above. The text 'SYSTEM SET' and '160°F' are replaced by '*STATUS input clamp' and 'START XX' and 'STOP XX' respectively. The status indicator * is present.</p>	<p>This screen indicates the boiler's input is being limited by the MOD-MAX value to optimize system efficiency. This will only be seen on a MASTER boiler.</p>

Status information screens

<div style="border: 1px solid black; padding: 5px;"> <p>XXXXXXXX *</p>  <p style="text-align: right;">*STATUS retry strt START XX STOP XX</p> </div>	<p>This screen indicates the control is attempting to re-initiate the ignition control because the ignition control did not begin PRE-PURGE. For more information see CALL SERVICE LOG entry.</p>
<div style="border: 1px solid black; padding: 5px;"> <p>XXXXXXXX *</p>  <p style="text-align: right;">*STATUS MIN OFF START XX STOP XX</p> </div>	<p>This screen indicates that the boiler's has received a heat demand, but it's MINIMUM OFF time has not expired.</p>
<div style="border: 1px solid black; padding: 5px;"> <p>XXXXXXXX *</p>  <p style="text-align: right;">*STATUS ADAPTIVE IN START XX STOP XX</p> </div>	<p>This Screen indicates that the boiler's input is temporarily being limited to optimize the boiler's efficiency.</p>
<div style="border: 1px solid black; padding: 5px;"> <p>XXXXXXXX *</p>  <p style="text-align: right;">*STATUS H-NET LOST START XX STOP XX</p> </div>	<p>This screen indicates that the boiler is running in LOCAL MODE because it has lost H-NET communications with the MASTER, and the failsafe mode has been activated.</p>

Status Screen Fault Display

There are numerous interlock switches and software limits that are detected. Each of these, when tripped will produce a display message, an audible beeping, and an alarm relay closure. The fault is displayed first, then after a second, the time the fault occurred is displayed. This cycle will keep occurring until the fault is cleared.

These faults and interlocks are:

HIGH LIMIT:

When the high limit aquastat trips the following message is displayed:



The high limit interlock breaks power to the ignition control (shutting it off) and effectively removes any chance of the gas valve receiving power. The HeatNet series control will remain powered to display the fault, latch the alarm relay/audible beeper, and to access the log. The interlock is located on J5, HIGH LIMIT. Ensure power is present on the input to the High Limit Control.

SPARE 4:

This is a reserved interlock input that is user defined. The interlock is located on J5B, SPARE 4.



DELTA TEMPERATURE WARNING:

If the temperature difference across the boiler measured from RETURN water to SUPPLY water exceeds the EXCHR DELTA T RANGE, setting this message will be displayed.

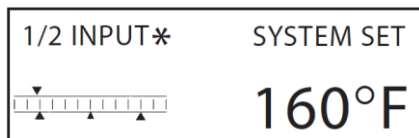

LOW WATER CUTOFF:

If there is a low water condition reported by the low water cutoff switch this fault is displayed. Check that there is water flow and water in the boiler. There is a reset switch located on the LWCO box. The interlock connection is located on J5B, LWCO.

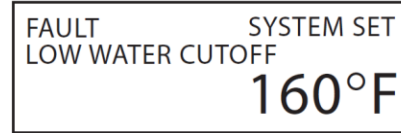

VAR FREQ DRIVE:

The variable frequency drive, which controls a non Ametek blower, if supported, reports this fault. It may be caused in the event of over current or an internal VFD fault that would cause it to shut down. If this is the case, check the fault indicators on the VFD. The interlock is located on J5B, VFD.

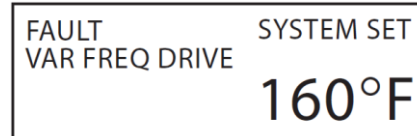

GAS PRESSURE:

The gas pressure switches (high pressure and low pressure) are connected in series, so if either trip, a fault will be reported here. A reset switch is located on the gas pressure switches. The interlock is located on J15B, GAS PR.

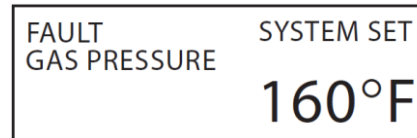

SYSTEM WATER FLOW:

Once the HeatNet series boiler receives a call for heat, it closes the system circulator pump relay. It then waits 10 seconds or more (adjustable) to prove flow. If there is no flow, the flow switch alarm will be set. Every 10 seconds the circulator pump relay will cycle ON for 10 seconds and then OFF for 10 seconds to try and establish flow. The interlock connection is located on J5B, SYSTEM WTR FLOW.

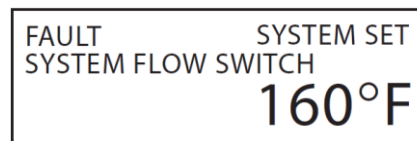

WTR FLW LOCAL:

Once the HeatNet series boiler receives a call for heat, it closes the LOCAL PUMP/VALVE relay. It then waits 10 seconds or more (adjustable) to prove flow. If there is no flow, the flow switch alarm will be set. Every 10 seconds the circulator pump relay will cycle ON for 10 seconds and then OFF for 10 seconds to try and establish flow. The interlock connection is located on J5B, WTR FLW.

FAULT	SYSTEM SET
WATER FLOW SWITCH	160°F

IGNITION CTRL ALARM:

The ignition control alarm is displayed if the ignition control detects a fault. This could be a flame failure, air proving switch, or other fault associated with the ignition control. When this fault occurs, you will need to refer to the ignition control for the reason.

FAULT	SYSTEM SET
IGNITION CTRL ALARM	160°F

COMBUST AIR DAMPER:

If the combustion air damper has been selected for use (AUX FUNCTIONS), and the proof switch does not make, this fault will be displayed.

FAULT	SYSTEM SET
COMBUSTION AIR DAMPER	160°F

When the master boiler receives a call for heat and needs to start a boiler, the DAMPER relay closes on J13. If the combustion air damper does not prove within the proof time specified in the combustion air damper menu, the boiler will not start and then display the fault. A combustion damper fault on a boiler can only be cleared by power cycling.

OPEN *** SENSOR :**

If the open sensor fault is displayed, the sensor in the position reported was originally detected, but has since opened. The boiler will shut down on any OPEN sensor except the OUSTSIDE AIR sensor.

FAULT	SYSTEM SET
OPEN OUTSIDE SENSOR	160°F

SHORTED *** SENSOR:**

If the shorted sensor fault is displayed, the sensor in the position reported was originally detected, but has since shorted. The boiler will shut down on any SHORTED sensor except the OUSTSIDE AIR sensor.

FAULT	SYSTEM SET
SHORTED OUTSIDE SENSOR	160°F

AIR SWITCH:

If the IGNITION control closes its blower relay, the control does not see the PILOT relay close within (2) minutes, and the AIR PRESSURE switch is made, this message will be displayed. This alarm protects the boiler from freeze ups being caused by a blower bringing in cold outside air with no fire.

FAULT	SYSTEM SET
AIR SWITCH (BLOWER)	160°F

CALL SERVICE:

If the H-Net control closes the last interlock string entering the ignition control and the ignition control never closes its Blower Relay, the H-Net control will wait 2 minutes. The H-Net control will then retry for the duration of the local pump post purge time and then retry the ignition sequence. During this time “retry strt” will be displayed in the status screen. After (5) attempts the H-Net control will lock out and display call service.

FAULT	SYSTEM SET
CALL SERVICE	160°F

DELTA TEMPERATURE WARNING:

If the temperature difference across the boiler and measured from RETURN water to SUPPLY water exceeds “EXCHGR DELTA” this message will be displayed. This can be set to an alarm condition in the AUX FUNCTIONS menu. High delta temperatures can result in damage to the boiler.

RUN %54	SYSTEM SET
DELTA TEMP > 40°F	
	160°F

BLOWER, RPM HIGH: (Ametek Blower)

If the signal from the HeatNet control board to the Ametek blower exceeds the factory limits, or the blower “runs away” (excessive speed), this message will be displayed. With this event, the HeatNet control will lockout the boiler and the boiler will require a manual reset to restart. Operation of the blower above the boiler’s maximum blower rpm setting could over fire the boiler.

FAULT	TACH
BLOWER, RPM HIGH	
HIGH FIRE	0

Line 4 Log Entries:

The following table lists the messages on line # 4 of the log's display.

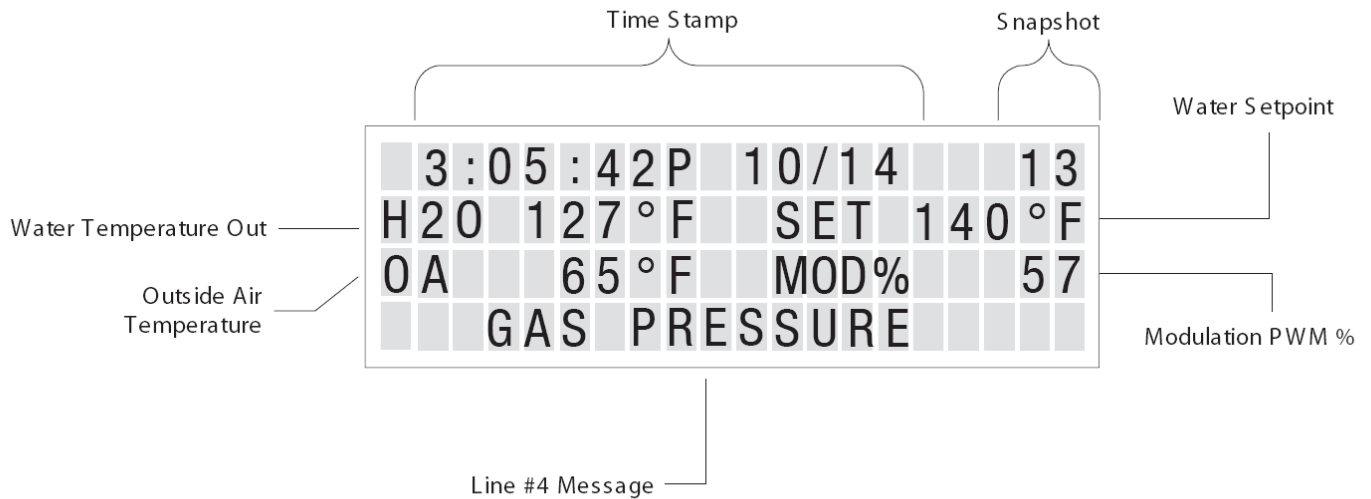

Line # 4 Message	Description
SETBACK IS ACTIVE SETBACK EXPIRED	If any of the (4) temperature setbacks are active these log entries will be displayed in the log.
NO LOCAL FLOW NO SYSTEM FLOW	If the test for flow fails these log entries will be displayed. The flow proving switches are wired to J11A and J11B.
COMBUSTION AIR FAIL	If the combustion air damper is used and does not prove across J10B DAMPER or J12B DAMPER, this message is displayed.
SYSTEM RESET -- ---- O: stack overflow, U: Stack Underflow (both are software faults) R: Reset Instruction (Firmware or Default load), W: Watchdog (Firmware code ran erroneous code and rebooted), P: Power-ON (Power switch toggled), B: Brown-out (Microcontroller saw a voltage less than 4.5 VDC)	When the control is reset, this log entry captures the reason the reset occurred.
OUTDOOR RESET	This log entry indicates that Warm Weather Shutdown is in effect.

Line # 4 Message	Description
HIGH DELTA TEMP	This log entry occurs when the temperature across the heat exchanger has been greater than the EXCHR DELTA T RANGE degrees F.
SHUTDOWN UV TEST	After 24 hours of continuous runtime the ignition control module needs to check it's UV detection circuit. An orderly shutdown and then a restart will occur. This log entry indicates that this has taken place. This is not a fault.
HIGH LIMIT EXCEEDED	If the mechanical aquastat trips due to it's high temperature setting having been exceeded, this log entry will occur.
IGNITION CTRL ALARM	The ignition control module has faulted while performing an ignition sequence, or while monitoring flame during normal operation.
IRI Alarm	If the gas valve proving circuit (if equipped) detects a gas pressure problem.
DOMESTIC HOT WATER	Indicates a call for DHW heating by either the DHW sensor or an external thermostat.
LOW WATER CUTOFF VAR FREQ DRIVE GAS PRESSURE SPARE 4 OP LIMIT MECH	These log entry faults are result of the interlocks connected to the 24VAC interlock inputs: J11A and J11B. Low Water Cutoff = Low water condition in boiler Var Freq Drive = The blowers Variable Frequency Drive has a problem Spare 4 = User installed interlock, Op Lim Mech = An external operator (aquastat).
START FAILED, RETRY	If the H-Net control closes the last interlock string entering the ignition control and the ignition control never closes its Blower Relay, the H-Net control will wait 2 minutes. The H-Net control will then retry for the duration of the local pump post purge time and then retry the ignition sequence. During this time "retry strt" will be displayed in the status screen. After (5) attempts the H-Net control will lock out and display call service. The Log will report the retries.
OP LIMIT REMOTE	The is the firmware Operating Limit as defined in SETUP:SETPOINTS:OPERATE LIM. When the Supply temperature exceeds this value, this event is logged.
OPEN OUTSIDE SENSOR, SUPPLY SENSOR, RETURN SENSOR, HEADER SENSOR, DHW SENSOR	If one of the 10k thermistor sensors was detected to be open or not connected, this fault will be logged.
SHORTED OUTSIDE SENSOR, SUPPLY SENSOR, RETURN SENSOR,	If one of the 10k thermistor sensors was detected to be shorted this fault will be logged.

Line # 4 Message	Description
HEADER SENSOR, DHW SENSOR	
AIR SWITCH(BLOWER)	If a call is made to the ignition control to start and the HeatNet control detects a blower start, but no Pilot within two minutes, the boiler locks out. This log entry indicates that the blower was ON with no flame in the boiler. Freeze up protection.
LOST BOILER # FOUND BOILER #	These log entries indicate that HeatNet has either discovered a boiler or lost a boiler using it's auto detection algorithm.
FAIL SAFE H-NET LOST FAIL SAFE LOW TEMP	If the Fail Safe modes are active, these log entries indicate that they became active for some reason and the boiler had entered Fail Safe mode.
BASE LOAD BOILER	The Base load Boiler Relay K8 is Active if ON Inactive if OFF
CALL SERVICE	If the H-Net control closes the last interlock string connected to the ignition control and the ignition control never closes its Blower Relay, the H-Net control will wait 2 minutes. The H-Net control will then retry for the duration of the local pump post purge time and then retry the ignition sequence. During this time "retry strt" will be displayed in the status screen. After (5) attempts the H-Net control will lock out and display call service.
BLOWER, RPM HIGH	The tachometer feedback from the blower indicated that it was above the maximum speed allowed for the boiler. Only used with Ametek blowers.



IN UNITED STATES: 260 NORTH ELM ST. • WESTFIELD, MA 01085 • (413) 564-5515 • FAX (413) 568-9613
IN CANADA: 7555 TRANMERE DRIVE • MISSISSAUGA, ONT. L5S 1L4 • (905) 670-5888 • FAX (905) 670-5782
www.knseries.com